

-duyar-
motorpompa®

ÜRÜN KATALOĞU
OCAK 2026



duyarpump.com

-duyar-
motorpompa®

Yenilikçi bina teknolojileri

EDE®
KONDANSATÖR
CAPACITOR



W
沃尔
SHENZHEN WOER HEAT
SHRINKABLE MATERIAL CO., LTD.
FİRMA ÜRETİMİDİR
"İSİ İLE DARALAN MAKARON"

HAWCON®
KONDANSATÖR

JURKAB®

Kaliteyi Seçme Nedeniniz...



MAKARON GRUBU

08

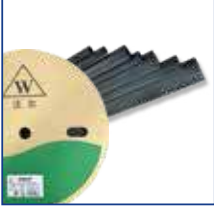

- Siyah Isı ile Daralan Makaronlar
- Renkli Isı ile Daralan Makaronlar
- 3/1 İçi Yapışkanlı Isı ile Daralan Makaron SBRSM-NF
- 3/1 İçi Yapışkanlı Isı ile Daralan Makaron (Rulo)
- Kablo Toplama Çorapları
- Metal Kablo Çekme Çorabı
- H - CLASS Silikonlu Makaronlar
- Cam Elyaf Makaronlar
- Renkli Cam Elyaf Makaronlar

KABLO BAĞLARI VE AKSESUARLAR

20



- Beyaz / Siyah / Renkli Kablo Bağları
- Etiketli Beyaz Kablo Bağları
- Panele Kafadan Sıkışan Beyaz Kablo Bağları
- Açılabilir Beyaz Kablo Bağları
- 304 Paslanmaz Çelik Kablo Bağları ve Etiket
- 304 Paslanmaz Çelik Polyester Kaplı Kablo Bağları
- Tırnaklı Kablo Bağı
- Yapışkanlı Kroşeler
- Vidalı Kroşeler
- Yapışkanlı Kablo Tutucu
- Kablo Klipsi
- Dübel Kroşe
- Baskılı Devre Taşıyıcıları
- Yapışkanlı Bükülebilir Klips
- Kablo Bağı Etiket Taşıyıcı
- Yapışkan Pano Etiketi
- Kapama Parçası Helezon Kablo Spiralleri
- EC Tipi Kablo İşaretleme

KABLO YÜKSÜKLERİ VE PABUÇLARI

31



- İzoleli Tek Giriş Yüksükler (Fransız/Alman Normu)
- İzoleli Çift Giriş Yüksükler (Fransız/Alman Normu)
- İzoleli Kablo Yüksükleri
- Yuvarlak Tip İzoleli Kablo Uçları
- Çatal Tip İzoleli Kablo Uçları
- Dişi Faston Tip İzoleli
- Dişi Faston Tip Tam İzoleli
- Dişi Faston Tip Tam İzoleli Polyamid Kablo Uçları
- Erkek Faston Tip İzoleli
- Erkek/Dişi Geri Dönüştürülebilir İzoleli
- Bayrak Tip Tam İzoleli Polyamid Kablo Uçları
- İzoleli Erkek Terminaller
- İzoleli Dişi Terminaller
- İzoleli Kablo Ucu Ek Mufları
- İğne Tip İzoleli
- Bıçak Tip İzoleli
- Ucu Kıvrık Bıçak Tip İzoleli Kablo Uçları
- Isı Büzüşmeli Ek Muf
- Vidalı Buat Klemensleri
- Hızlı Kablo Ekleme Parçası
- Standart Tip Sıkmalı Kablo Pabuçları
- Eko Tip Sıkmalı Kablo Pabuçları
- Eko Tip Ek Muflar
- Kaynaklı Tip Sıkmalı Kablo Pabuçları

İZOLESİZ KABLO UÇLARI VE KONNEKTÖRLERİ

50

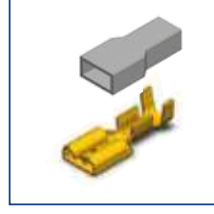

- İzolesiz Kablo Uçları ve Konnektörler

Ø22 BUTON GRUBU & LED SİNYALLER

54



- Yaylı Butonlar
- Işıklı Yaylı Butonlar
- Kalıcı Mandal Butonlar
- Kayıcı Mandal Butonlar
- Anahtarlı Kalıcı Butonlar
- Işıklı Kalıcı Mandal Butonlar
- Yardımcı Kontaktlar
- Kalıcı Mantar Buton
- Kalıcı Anahtarlı Mantar Buton
- Kayıcı Mantar Buton
- İkiz Buton
- Led Sinyaller
- Led'li Buzzer
- Voltmetre
- Ampermetre
- Potansiyometre
- Motorlu Siren
- Köprü Diyot
- ST Serisi Termik Sigorta

DAĞITICI ÜNİTELER & KOMPAKT ÇOK AMAÇLI KLEMENSLER

64



- 2 Kutuplu Dağıtıcı Üniteler
- 4 Kutuplu Dağıtıcı Üniteler
- W Otomat Rayı
- Trifaze Müşterek W Otomat Baraları
- Monofaze Müşterek W Otomat Baraları
- Nötr Vidalı Topraklama Baraları
- Pano İçi Termostatlar
- Universal Sayıcılar
- Kompakt Çok Amaçlı Klemensler
- Tek Damar İletkenler İçin Buat Klemensler
- 221 Serisi Kompakt Çok Amaçlı Klemensler
- Aydınlatma için Kablo Klemensler

EL ALETLERİ GRUBU

70



- Mekanik El Aletleri
- Kablo Soyma ve Kesme Aletleri
- Network Penseleri
- Kablo Bağı Sıkma Penseleri
- Mekanik SKP Papuç Sıkma Penseleri
- Hidrolik Papuç Sıkma Penseleri
- Unior Kontrol Kalemi ve Penseler
- İzetaş Kontrol Kalemi
- Knipex El Aletleri

KONDANSATÖR GRUBU

80

**HAWCON & EDE**

- Daimi Devre Motor ve Aydınlatma Kondansatörleri
- Daimi Devre Motor Kondans. Plastik Tüp Vidalı, Term.
- Motor İlk Hareket (Start) Kondansatörleri
- Fan Kondansatörleri Kare Tip (400 - 450 V)
- Daimi Devre Motor Kondans. Alüm. Tüp, Vidalı, Term.

KONDAŞ

- Standart Kutu Tip Güç Kondansatörleri
- Standart Silindirik Tip Güç Kondansatörleri

LEHİM TELLERİ VE HAVYA GRUBU

87



- Lehim Telleri
- Lehim Suyu Flux
- Lehim Pastaları
- WELLER Havya Grubu
- ER-SA Kalem ve Çekiç Havyalar
- UPX Set Havya
- CLASS Havya Grubu
- SOLOMON Set ve Kalem Havyalar
- SONAR Tabanca Havya

ÖLÇÜ ALETLERİ

95



- UNI-T Ölçü Aletleri
- Diğer Ölçü Aletleri

DAĞITICI ÜNİTELER

- 2 Kutuplu Dağıtıcı Üniteler
- 4 Kutuplu Dağıtıcı Üniteler

**YENİ İTHALATIMIZ**
*****BANT, SPREY VE SICAK HAVA TABANÇALARI**

99



- KSN Eriyen Bantlar
- Globe İzole Bantlar
- Çift Taraflı Bantlar
- Coroplast Tüylü ve Tüysüz Bez Bantlar
- Teflon Bantlar
- STEINEL Sıcak Hava Tabançaları ve Aksesuarları
- CARTELL Silikon Tabançaları ve Mum Silikonlar
- HAWCON Sprey Çeşitleri
- Perfects Sprey Çeşitleri

ANAHTAR VE SWITCH GRUBU

103



- Yerli Anahtar ve Switch Çeşitleri
- İthal Anahtar ve Switch Çeşitleri
- Born Klemens Banan Fiş Ve Krokodil Çeşitleri
- Fuse Yuva ve Cam Sigortalar

Ø22 BUTON GRUBU & LED SİNYALLER

- Yaylı Butonlar
- Işıklı Yaylı Butonlar
- Kalıcı Mandal Butonlar
- Kayıcı Mandal Butonlar
- Anahtarlı Kalıcı Butonlar
- Işıklı Kalıcı Mandal Butonlar
- Yardımcı Kontaklar
- Kalıcı Mantar Buton
- Kalıcı Anahtarlı Mantar Buton
- Kayıcı Mantar Buton
- İkiz Buton
- Led Sinyaller
- Led'li Buzzer
- Voltmetre
- Ampermetre
- Potansiyometre
- Motorlu Siren
- Köprü Diyot
- ST Serisi Termik Sigorta

**YENİ İTHALATIMIZ**

-duyar-
motorpompa®

Yenilikçi bina teknolojileri

MAKARON
GRUBU



沃尔

SHENZHEN WOER HEAT
SHRINKABLE MATERIAL CO., LTD.
FİRMA ÜRETİMİDİR
"ISI İLE DARALAN MAKARON"

KSN®



SİYAH ISI İLE DARALAN MAKARONLAR

İTHALATIMIZ

**沃尔**SHENZHEN WOER HEAT
SHRINKABLE MATERIAL CO., LTD.
FİRMA ÜRETİMİDİR
"ISI İLE DARALAN MAKARON"**TEKNİK ÖZELLİKLER****Malzeme:**

Polyolefin

Daralma Oranı: 2/1**Yanmazlık:**

Kendi kendine söner

Çalışma Sıcaklığı:

-55 °C + 125 °C (600V)



SİPARİŞ KODU	Ölçüler		Daralmadan Önce		Daralmadan Sonra		Makara (m)	Koli Mik. (m)	Metre Fiyatı (\$)
	inc	mm	(mm)		(mm)				
1001	-	0,8	1,1 ± 0,2	0,15 ± 0,05	0,50	0,28 ± 0,10	200	4.600	0,165 \$
1002	-	1	1,5 ± 0,2	0,15 ± 0,05	0,50	0,28 ± 0,10	200	3.200	0,090 \$
1003	-	1,2	2,0 ± 0,2	0,15 ± 0,05	0,70	0,30 ± 0,10	200	3.000	0,090 \$
1004	-	1,5	2,0 ± 0,2	0,18 ± 0,05	0,85	0,32 ± 0,10	200	2.400	0,097 \$
1005	1/16	1,6	2,0 ± 0,3	0,15 ± 0,05	0,80	0,28 ± 0,10	200	3.200	0,104 \$
1006	-	2	2,5 ± 0,2	0,18 ± 0,05	0,60	0,28 ± 0,10	200	3.000	0,115 \$
1007	3/32	2,4	3,0 ± 0,3	0,18 ± 0,05	1,20	0,35 ± 0,10	200	3.000	0,115 \$
1008	-	2,5	3,0 ± 0,2	0,18 ± 0,05	1,30	0,38 ± 0,10	200	2.600	0,150 \$
1009	-	3	3,5 ± 0,2	0,18 ± 0,05	1,50	0,40 ± 0,10	200	2.200	0,160 \$
1010	1/8	3,2	3,5 ± 0,4	0,18 ± 0,05	1,60	0,40 ± 0,10	200	2.200	0,160 \$
1011	-	3,5	4,0 ± 0,2	0,22 ± 0,05	1,80	0,42 ± 0,10	200	1.800	0,170 \$
1012	-	4	4,5 ± 0,2	0,25 ± 0,05	2,00	0,45 ± 0,10	200	1.400	0,200 \$
1013	-	4,5	5,0 ± 0,2	0,25 ± 0,05	2,30	0,50 ± 0,10	100	1.000	0,230 \$
1014	3/16	4,8	5,2 ± 0,4	0,25 ± 0,05	2,40	0,50 ± 0,10	100	1.000	0,230 \$
1015	-	5	5,5 ± 0,2	0,25 ± 0,05	2,50	0,55 ± 0,10	100	900	0,250 \$
1016	-	6	6,5 ± 0,2	0,28 ± 0,05	3,00	0,55 ± 0,10	100	700	0,290 \$
1017	1/4	6,4	7,0 ± 0,4	0,28 ± 0,05	3,20	0,55 ± 0,10	100	700	0,290 \$
1018	-	7 YASSI	7,5 ± 0,3	0,28 ± 0,05	3,50	0,55 ± 0,10	100	1.400	0,340 \$
1019	-	7 BORU	7,5 ± 0,3	0,28 ± 0,05	3,50	0,55 ± 0,10	100	500	0,368 \$
1020	-	8 YASSI	8,5 ± 0,3	0,28 ± 0,05	4,00	0,60 ± 0,10	100	1.300	0,345 \$
1021	-	8 BORU	8,5 ± 0,3	0,28 ± 0,05	4,00	0,60 ± 0,10	100	500	0,397 \$
1022	-	9 YASSI	9,5 ± 0,3	0,30 ± 0,08	4,50	0,60 ± 0,10	100	1.200	0,350 \$
1023	-	9 BORU	9,5 ± 0,3	0,30 ± 0,08	4,50	0,60 ± 0,10	50	300	0,450 \$
1024	3/8	9,5	10,0 ± 0,5	0,30 ± 0,08	4,80	0,60 ± 0,10	100	1.200	0,350 \$
1025	-	10	10,5 ± 0,3	0,30 ± 0,08	5,00	0,60 ± 0,10	100	1.100	0,390 \$
1026	-	11	11,5 ± 0,3	0,30 ± 0,08	5,50	0,60 ± 0,10	100	1.100	0,442 \$

SIYAH ISI İLE DARALAN MAKARONLAR

İTHALATIMIZ



TEKNİK ÖZELLİKLER

Malzeme:

Polyolefin

Daralma Oranı: 2/1

Yanmazlık:

Kendi kendine söner

Çalışma Sıcaklığı:

-55 °C + 125 °C (600V)



SİPARİŞ KODU	Ölçüler		Daralmadan Önce (mm)		Daralmadan Sonra (mm)		Makara (m)	Koli Mik. (m)	Metre Fiyatı (\$)
	inc	mm							
1027	-	12	12,5 ± 0,3	0,30 ± 0,08	6,00	0,60 ± 0,10	100	1.000	0,450 \$
1028	1/2	12,7	13,0 ± 0,5	0,30 ± 0,08	6,40	0,60 ± 0,10	100	1.000	0,450 \$
1029	-	13	13,5 ± 0,3	0,35 ± 0,10	6,50	0,65 ± 0,10	100	900	0,480 \$
1030	-	14	14,5 ± 0,3	0,35 ± 0,10	7,00	0,65 ± 0,10	100	900	0,570 \$
1031	-	15	15,5 ± 0,3	0,35 ± 0,10	7,00	0,65 ± 0,10	100	800	0,675 \$
1032	-	16	15,5 ± 0,3	0,35 ± 0,10	7,00	0,65 ± 0,10	100	800	0,750 \$
1033	-	17	16,5 ± 0,4	0,40 ± 0,12	8,00	0,70 ± 0,10	100	700	0,975 \$
1034	-	18	17,5 ± 0,4	0,40 ± 0,15	8,50	0,80 ± 0,15	100	700	0,980 \$
1035	3/4	19,1	19,0 ± 0,5	0,40 ± 0,15	9,00	0,80 ± 0,15	100	700	0,980 \$
1036	4/5	20	20,5 ± 0,6	0,40 ± 0,15	9,50	0,80 ± 0,15	100	600	1,250 \$
1037	-	22	21,0 ± 0,6	0,40 ± 0,15	10,00	0,80 ± 0,15	100	600	1,550 \$
1038	1	25,4	23,0 ± 0,5	0,40 ± 0,15	11,00	0,80 ± 0,15	50	300	1,650 \$
1039	-	30	25,6 ± 0,7	0,50 ± 0,15	12,70	0,80 ± 0,15	50	250	2,150 \$
1040	1-1/4	32	31,5 ± 1,0	0,50 ± 0,15	15,00	0,95 ± 0,15	50	250	2,150 \$
1041	-	35	33,0 ± 0,7	0,50 ± 0,15	15,50	0,95 ± 0,15	50	200	2,720 \$
1042	1-1/2	38	36,5 ± 1,0	0,50 ± 0,15	17,50	0,90 ± 0,15	50	200	3,000 \$
1043	-	40	40,0 ± 0,7	0,50 ± 0,15	19,10	1,00 ± 0,15	50	200	3,000 \$
1044	2	51	41,5 ± 1,0	0,55 ± 0,15	20,00	1,00 ± 0,15	25	125	3,800 \$
1045	-	60	52,5 ± 0,7	0,55 ± 0,15	25,40	0,95 ± 0,15	25	100	5,100 \$
1046	-	70	60	0,65 ± 0,15	30,00	1,30 ± 0,20	25	75	6,850 \$
1047	3	76	70	0,65 ± 0,15	35,00	1,30 ± 0,20	25	75	7,500 \$
1048	-	80	80,0 ± 1,0	0,65 ± 0,15	38,10	1,30 ± 0,20	25	75	7,500 \$
1049	-	90	80	0,65 ± 0,15	40,00	1,46 ± 0,20	25	50	8,500 \$
1050	4	102	90	0,65 ± 0,15	45,00	1,46 ± 0,20	25	50	9,500 \$
1051	5	120	105,0 ± 1,0	0,65 ± 0,20	50,80	1,46 ± 0,20	25	50	13,000 \$
1052	-	150	120	0,65 ± 0,20	63,50	1,56 ± 0,20	25	50	20,000 \$
1053	-	180	150	0,65 ± 0,20	75,00	1,56 ± 0,20	25	25	28,000 \$

RENKLİ ISI İLE DARALAN MAKARONLAR**İTHALATIMIZ**

沃尔
SHENZHEN WOER HEAT
SHRINKABLE MATERIAL CO., LTD.
FİRMA ÜRETİMİDİR
"ISI İLE DARALAN MAKARON"

**TEKNİK ÖZELLİKLER****Malzeme:**

Polyolefin

Daralma Oranı: 2/1**Yanmazlık:**

Kendi kendine söner

Çalışma Sıcaklığı:

-55 °C + 125 °C (600V)

BEYAZ**ŞEFFAF****MAVİ****YEŞİL****KIRMIZI****SARI****GRİ**

Ölçüler		SİPARİŞ KODU							Makara	Koli	Metre Fiyatı
Inc	mm	BEYAZ	ŞEFFAF	MAVİ	YEŞİL	KIRMIZI	SARI	GRİ	(m)	Miktarı (m)	(\$)
1/16	1,6	1100	1132	1162	1192	1222	1252	1282	200	3.200	0,110 \$
-	2	1101	1133	1163	1193	1223	1253	1283	200	3.000	0,140 \$
3/32	2,4	1102	1134	1164	1194	1224	1254	1284	200	3.000	0,140 \$
-	2,5	1103	1135	1165	1195	1225	1255	1285	200	2.600	0,165 \$
1/8	3,2 (Yassı)	1105	1137	1167	1197	1227	1257	1287	100	1.700	0,220 \$
1/8	3,2 (Boru)	1104	1136	1166	1291	1226	1256	1286	200	2.200	0,190 \$
-	3,5 (Yassı)	1107	-	-	-	-	-	-	100	1.700	0,230 \$
-	3,5 (Boru)	1106	-	-	-	-	-	-	200	1.800	0,210 \$
3/16	4,8 (Yassı)	1109	1139	1169	1199	1229	1259	1289	100	1.600	0,300 \$
3/16	4,8 (Boru)	1108	1138	1168	1198	1228	1258	1288	100	1.000	0,260 \$
-	5	1110	1140	1170	1200	1230	1260	1290	100	900	0,320 \$
1/4	6,4 (Yassı)	1112	1142	1172	1202	1232	1262	1292	100	1.500	0,380 \$
1/4	6,4 (Boru)	1111	1141	1171	1201	1231	1261	1291	100	700	0,330 \$
-	7 (Yassı)	1113	1143	1173	1203	1233	1263	1293	100	1.400	0,340 \$
3/8	9,5	1114	1144	1174	1204	1234	1264	1294	100	1.200	0,400 \$
1/2	12,7	1115	1145	1175	1205	1235	1265	1295	100	1.000	0,530 \$
-	16	1116	1146	1176	1206	1236	1266	1296	100	800	0,860 \$
3/4	19,1	1117	1147	1177	1207	1237	1267	1297	100	700	1,380 \$
4/5	20	1118	1148	1178	1208	1238	1268	1298	100	600	1,500 \$
1	25,4	1119	1149	1179	1209	1239	1269	1299	50	300	1,860 \$
1-1/4	32	1120	1150	1180	1210	1240	1270	1300	50	250	2,400 \$
-	35	1121	1151	1181	1211	1241	1271	1301	50	200	3,300 \$
1-1/2	38	1122	1152	1182	1212	1242	1272	1302	50	200	3,500 \$
2	51	1123	1153	1183	1213	1243	1273	1303	25	125	4,200 \$
-	60	1124	1154	1184	1214	1244	1274	1304	25	100	6,000 \$
-	70	1125	1155	1185	1215	1245	1275	1305	25	75	7,500 \$
3	76	1126	1156	1186	1216	1246	1276	1306	25	75	8,300 \$
-	80	1127	1157	1187	1217	1247	1277	1307	25	75	8,300 \$
4	102	1128	1158	1188	1218	1248	1278	1308	25	50	12,000 \$
5	120	1129	1159	1189	1219	1249	1279	1309	25	50	18,000 \$
	150	1130	1160	1190	1220	1250	1280	1310	25	50	30,00 \$
	180	1131	1161	1191	1221	1251	1281	1311	25	25	45,00 \$

RENKLİ ISI İLE DARALAN MAKARONLAR

İTHALATIMIZ

**沃尔**SHENZHEN WOER HEAT
SHRINKABLE MATERIAL CO., LTD.
FİRMA ÜRETİMİDİR
"ISI İLE DARALAN MAKARON"**SARI****YEŞİL**

SİPARİŞ KODU	Ölçüler		Makara (m)	Koli Miktarı (m)	Metre Fiyatı (\$)
	Inc	mm			
1312	1/16	1,6	200	3.200	0,64 \$
1314	3/32	2,4	200	3.000	0,42 \$
1316	1/8	3,2	200	2.200	0,43 \$
1318	3/16	4,8	100	1.000	0,44 \$
1321	1/4	6,4	100	700	0,50 \$
1324	3/8	9,5	100	1.200	0,68 \$
1325	1/2	12,7	100	1.000	0,95 \$
1326	-	16	100	800	1,45 \$
1327	3/4	19,1	100	700	1,70 \$
1328	4/5	20	100	600	1,88 \$
1329	1	25,4	50	300	2,75 \$
1330	1-1/4	32	50	250	3,70 \$
1332	1-1/2	38	50	200	5,00 \$
1333	2	51	25	125	7,00 \$
1334	-	60	25	100	10,20 \$
1336	3	76	25	75	16,00 \$
1337	-	80	25	75	16,00 \$
1338	4	102	25	50	25,00 \$

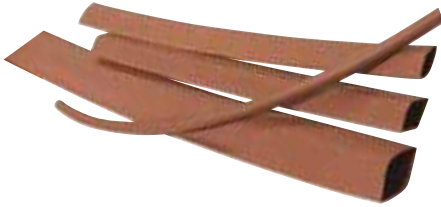
KAHVERENGİ

SİPARİŞ KODU	Ölçüler		Makara (m)	Koli Miktarı (m)	Metre Fiyatı (\$)
	Inc	mm			
1344	3/32	2,4	200	3.000	0,15 \$
1346	1/8	3,2	200	2.200	0,22 \$
1348	3/16	4,8	100	1.000	0,29 \$
1351	1/4	6,4	100	700	0,37 \$
1354	3/8	9,5	100	1.200	0,45 \$
1355	1/2	12,7	100	1.000	0,58 \$
1356	-	16	100	800	1,00 \$
1357	3/4	19,1	100	700	1,40 \$
1358	4/5	20	100	600	1,57 \$
1359	1	25,4	50	300	2,10 \$
1360	1-1/4	32	50	250	2,75 \$
1361	-	35	50	200	3,90 \$
1362	1-1/2	38	50	200	4,00 \$
1363	2	51	25	125	5,00 \$
1364	-	60	25	100	7,40 \$
1365	-	70	25	75	8,50 \$
1366	3	76	25	75	9,00 \$
1367	-	80	25	75	9,00 \$
1368	4	102	25	50	13,40 \$
1369	5	120	25	50	19,00 \$
1370		150	25	50	35,00 \$
1371		180	25	25	50,00 \$

TEKNİK ÖZELLİKLER**Malzeme:**

Polyolefin

Daralma Oranı: 2/1**Yanmazlık:**

Kendi kendine söner

Çalışma Sıcaklığı:

-55 °C + 125 °C (600V)



3/1 İÇİ YAPIŞKANLI ISI İLE DARALAN MAKARON SBRSM-NF

İTHALATIMIZ

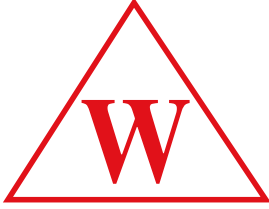
**沃尔**SHENZHEN WOER HEAT
SHRINKABLE MATERIAL CO., LTD.
FİRMA ÜRETİMİDİR

"ISI İLE DARALAN MAKARON"

**TEKNİK ÖZELLİKLER****Malzeme:**

Polyolefin

Daralma Oranı: 3/1**Yanmazlık:**

Kendi kendine söner

Çalışma Sıcaklığı:

-55 °C + 125 °C

SİPARİŞ KODU	Ölçü (mm)	Daralmadan Sonra (mm)				Boy (m)	Koli Miktarı (Adet)	Metre Fiyatı (\$)
		Çap	Cidar Kalınlığı	Yapışkan Katmanı	Top. Cidar Kalınlığı			
1401	6	2	1,40 ± 0,20	0,45 ± 0,10	1,85 ± 0,25	1,22 m	400	1,25 \$
1402	9	3	1,40 ± 0,20	0,50 ± 0,10	1,90 ± 0,25	1,22 m	200	1,70 \$
1403	12	3	1,40 ± 0,20	0,50 ± 0,10	1,90 ± 0,25	1,22 m	150	2,25 \$
1404	16	5	1,50 ± 0,20	0,55 ± 0,15	2,15 ± 0,30	1,22 m	200	3,20 \$
1405	19,1	5,6	1,80 ± 0,20	0,60 ± 0,15	2,40 ± 0,30	1,22 m	150	4,40 \$
1406	22	6	2,00 ± 0,30	0,60 ± 0,15	2,60 ± 0,30	1,22 m	100	4,50 \$
1407	25	8	2,00 ± 0,30	0,60 ± 0,15	2,70 ± 0,30	1,22 m	90	4,80 \$
1408	28	6	2,40 ± 0,30	0,95 ± 0,20	3,30 ± 0,35	1,22 m	75	5,10 \$
1409	33	8	2,50 ± 0,30	0,80 ± 0,15	3,30 ± 0,35	1,22 m	50	5,70 \$
1410	38,1	12	2,40 ± 0,30	0,80 ± 0,15	3,30 ± 0,35	1,22 m	40	6,30 \$
1411	43,2	12,7	2,50 ± 0,30	0,80 ± 0,15	3,30 ± 0,35	1,22 m	35	7,10 \$
1412	56	16	2,50 ± 0,30	0,80 ± 0,15	3,30 ± 0,35	1,22 m	25	8,00 \$
1413	65	19	2,50 ± 0,30	0,80 ± 0,25	3,30 ± 0,45	1,22 m	25	9,10 \$
1414	75	22	2,90 ± 0,30	0,80 ± 0,15	3,70 ± 0,40	1,22 m	25	11,30 \$
1415	95	30	3,00 ± 0,30	0,80 ± 0,15	3,80 ± 0,40	1,22 m	20	16,00 \$
1416	115	34	3,00 ± 0,30	0,80 ± 0,15	3,80 ± 0,40	1,22 m	20	19,00 \$
1417	140	42	3,00 ± 0,30	0,80 ± 0,15	3,80 ± 0,40	1,22 m	20	25,00 \$
1418	180	65	3,10 ± 0,30	0,80 ± 0,15	3,90 ± 0,40	1,22 m	15	38,00 \$
1419	200	69	3,10 ± 0,30	0,80 ± 0,15	3,90 ± 0,40	1,22 m	15	54,00 \$

3/1 İÇİ YAPIŞKANLI ISI İLE DARALAN MAKARON (RULO)

İTHALATIMIZ



SİPARİŞ KODU	Ölçü		Daralmadan Sonra (mm)			Rulo (m)	Koli Miktarı (m)	Metre Fiyatı (\$)
	Inc	mm	İç Çap (mm)	Yapışkan Katmanı	Cidar Kalınlığı			
1420	1/8	3,2	1,00	0,40 ± 0,10	0,95 ± 0,15	200	1.800	0,65 \$
1421	3/16	4,8	1,60	0,40 ± 0,10	1,10 ± 0,15	100	900	0,80 \$
1422	1/4	6,4	2,20	0,45 ± 0,12	1,20 ± 0,15	100	600	1,20 \$
1423	3/8	9,5	3,20	0,50 ± 0,12	1,45 ± 0,20	50	300	1,60 \$
1424	1/2	12,7	4,20	0,50 ± 0,12	1,70 ± 0,20	25	250	2,20 \$
1425	5/8	16	5,20	0,55 ± 0,15	1,80 ± 0,20	25	225	2,85 \$
1426	3/4	19,1	6,30	0,55 ± 0,15	2,00 ± 0,20	25	175	3,45 \$
1427	1	25,4	8,50	0,55 ± 0,15	2,10 ± 0,25	25	150	4,60 \$

MAKARON SETİ (328 PARÇA)



SİPARİŞ KODU	ÜRÜN KODU	CİNSİ	FİYATI \$ / Ad.
1451	HWA-274/1	Isı ile Daralan Makaron 328 Parça, 8 Boy, 5 Renk	3,80 \$

MAKARON SETİ (530 PARÇA)



SİPARİŞ KODU	ÜRÜN KODU	CİNSİ	FİYATI \$ / Ad.
1452	HWA-274/2	Isı ile Daralan Makaron 530 Parça, 12 Boy, 5 Renk	4,50 \$

MAKARON SETİ (750 PARÇA)



SİPARİŞ KODU	ÜRÜN KODU	CİNSİ	FİYATI \$ / Ad.
1453	HWA-274/3	Isı ile Daralan Makaron 750 Parça, 12 Boy, 5 Renk	5,50 \$

LEHİMLİ MAKARON SETİ (100 PARÇA)



SİPARİŞ KODU	ÜRÜN KODU	CİNSİ	FİYATI \$ / Ad.
3112	HWA-274S	Lehimli Makaron 100 Parça, 4 Boy, 4 Renk	9,00 \$

KSN® KABLO TOPLAMA ÇORAPLARI

İTHALATIMIZ

SİPARİŞ KODU	ÜRÜN KODU	CİNSİ	GENİŞLEME ARALIĞI		METRE	METRE FİYAT (\$)	
			MİN.	MAX.			
1461	ÇORAP-001	3 mm Kablo Toplama Çorabı / Siyah	1	6	100	0,24 \$	
1462	ÇORAP-002	4 mm Kablo Toplama Çorabı / Siyah	2	7	100	0,26 \$	
1463	ÇORAP-003	5 mm Kablo Toplama Çorabı / Siyah	3	9	100	0,27 \$	
1464	ÇORAP-004	6 mm Kablo Toplama Çorabı / Siyah	3	9	100	0,28 \$	
1465	ÇORAP-005	8 mm Kablo Toplama Çorabı / Siyah	5	16	100	0,30 \$	
1466	ÇORAP-006	10 mm Kablo Toplama Çorabı / Siyah	7	19	100	0,36 \$	
1467	ÇORAP-007	12 mm Kablo Toplama Çorabı / Siyah	8	24	100	0,43 \$	
1468	ÇORAP-008	15 mm Kablo Toplama Çorabı / Siyah	10	27	100	0,48 \$	
1469	ÇORAP-009	20 mm Kablo Toplama Çorabı / Siyah	14	30	100	0,56 \$	
1470	ÇORAP-010	25 mm Kablo Toplama Çorabı / Siyah	18	35	100	0,72 \$	
1471	ÇORAP-011	30 mm Kablo Toplama Çorabı / Siyah	20	50	50	0,87 \$	
1472	ÇORAP-012	40 mm Kablo Toplama Çorabı / Siyah	30	60	50	1,40 \$	
1473	ÇORAP-013	50 mm Kablo Toplama Çorabı / Siyah	40	80	50	1,87 \$	
1474	ÇORAP-014	70 mm Kablo Toplama Çorabı / Siyah	64	120	50	3,50 \$	
1489	KD-8-3	CUTTER Kablo Çorabı Kesme Aleti				1 Adet	290,00 \$
1490	KD-8-3-Y	CUTTER Kablo Çorabı Kesme Yedek Bıçağı				1 Adet	30,00 \$



Çalışma Sıcaklığı
-50 °C | +150 °C



KSN
KABLO ÇORAPLARI



**Çorap Kesme
Makinesi**

KSN® METAL KABLO ÇEKME ÇORABI

İTHALATIMIZ



ÇAP (mm)	SIKMA ÇAP	BOY (cm)	KAPASİTE (Kg)	ÇİFT ASKI TİP SİP. KODU	ÇİFT ASKI TİP ADET / (₺)	TEK ASKI TİP SİP. KODU	TEK ASKI TİP ADET / (₺)
10	5 - 12	60	800 kg	1500	950,00 ₺	1491	800,00 ₺
20	11 - 20	80	1,000 kg	1501	1.050,00 ₺	1492	900,00 ₺
30	21 - 30	90	1,500 kg	1502	1.200,00 ₺	1493	1.025,00 ₺
40	31 - 40	100	2,000 kg	1503	1.300,00 ₺	1494	1.100,00 ₺
60	41 - 60	130	2,500 kg	1504	1.600,00 ₺	1495	1.450,00 ₺
80	61 - 80	150	3,500 kg	1505	1.800,00 ₺	1496	1.650,00 ₺
100	81 - 100	165	4,000 kg	1506	2.425,00 ₺	1497	2.050,00 ₺
120	101 - 120	175	4,500 kg	1507	2.750,00 ₺	1498	2.275,00 ₺
140	121 - 140	180	5,000 kg	1508	3.750,00 ₺	1499	3.300,00 ₺

KSN® H - CLASS SİLİKONLU MAKARONLAR



İTHALATIMIZ

KSN®
H - CLASS MAKARON

TEKNİK ÖZELLİKLER

Malzeme:

Silikon İzoleli Cam Elyaf
Örgü Makaron

Çalışma Sıcaklığı:

-60 °C + 250 °C



SİPARİŞ KODU	ÜRÜN KODU	CİNSİ		RULO (m)	KOLİ MİKTARI (m)	FİYAT (\$) (m)
1623	KSNHCL-023	0,8 mm	H - Class Makaron 2,5 KV	100	1.500	0,315 \$
1624	KSNHCL-024	1 mm	H - Class Makaron 2,5 KV	100	1.500	0,290 \$
1625	KSNHCL-025	1,5 mm	H - Class Makaron 2,5 KV	100	1.500	0,315 \$
1626	KSNHCL-026	2 mm	H - Class Makaron 2,5 KV	100	1.000	0,320 \$
1627	KSNHCL-027	2,5 mm	H - Class Makaron 2,5 KV	100	1.000	0,340 \$
1628	KSNHCL-028	3 mm	H - Class Makaron 2,5 KV	100	600	0,350 \$
1629	KSNHCL-029	4 mm	H - Class Makaron 2,5 KV	100	500	0,470 \$
1630	KSNHCL-030	5 mm	H - Class Makaron 2,5 KV	100	500	0,570 \$
1631	KSNHCL-031	6 mm	H - Class Makaron 2,5 KV	100	500	0,690 \$
1632	KSNHCL-032	7 mm	H - Class Makaron 2,5 KV	100	500	0,800 \$
1633	KSNHCL-033	8 mm	H - Class Makaron 2,5 KV	100	400	0,950 \$
1634	KSNHCL-034	10 mm	H - Class Makaron 2,5 KV	100	400	1,260 \$
1635	KSNHCL-035	12 mm	H - Class Makaron 2,5 KV	50	250	1,580 \$
1636	KSNHCL-036	14 mm	H - Class Makaron 2,5 KV	50	250	1,890 \$
1637	KSNHCL-037	16 mm	H - Class Makaron 2,5 KV	50	200	2,520 \$
1638	KSNHCL-038	18 mm	H - Class Makaron 2,5 KV	50	200	3,350 \$
1639	KSNHCL-039	20 mm	H - Class Makaron 2,5 KV	50	200	4,500 \$
1640	KSNHCL-040	25 mm	H - Class Makaron 2,5 KV	25	125	8,000 \$
1641	KSNHCL-041	30 mm	H - Class Makaron 2,5 KV	25	100	11,800 \$
1642	KSNHCL-042	35 mm	H - Class Makaron 2,5 KV	25	100	13,800 \$
1643	KSNHCL-043	40 mm	H - Class Makaron 2,5 KV	25	100	21,000 \$
1644	KSNHCL-044	50 mm	H - Class Makaron 2,5 KV	25	75	45,150 \$

KSN® H - CLASS SİLİKONLU MAKARONLAR**1,5 kV****İTHALATIMIZ**

SİPARİŞ KODU	ÜRÜN KODU	CİNSİ		RULO (m)	KOLİ MİKTARI (m)	FİYAT (\$) (m)
1601	KSNHCL-001	0,8 mm	H - Class Makaron 1,5 KV	100	1.500	- \$
1602	KSNHCL-002	1 mm	H - Class Makaron 1,5 KV	100	1.500	0,230 \$
1603	KSNHCL-003	1,5 mm	H - Class Makaron 1,5 KV	100	1.500	- \$
1604	KSNHCL-004	2 mm	H - Class Makaron 1,5 KV	100	1.000	0,250 \$
1605	KSNHCL-005	2,5 mm	H - Class Makaron 1,5 KV	100	1.000	0,260 \$
1606	KSNHCL-006	3 mm	H - Class Makaron 1,5 KV	100	600	0,280 \$
1607	KSNHCL-007	4 mm	H - Class Makaron 1,5 KV	100	500	0,380 \$
1608	KSNHCL-008	5 mm	H - Class Makaron 1,5 KV	100	500	0,460 \$
1609	KSNHCL-009	6 mm	H - Class Makaron 1,5 KV	100	500	0,590 \$
1610	KSNHCL-010	7 mm	H - Class Makaron 1,5 KV	100	500	0,650 \$
1611	KSNHCL-011	8 mm	H - Class Makaron 1,5 KV	100	400	0,800 \$
1612	KSNHCL-012	10 mm	H - Class Makaron 1,5 KV	100	400	1,071 \$
1613	KSNHCL-013	12 mm	H - Class Makaron 1,5 KV	50	250	1,380 \$
1614	KSNHCL-014	14 mm	H - Class Makaron 1,5 KV	50	250	1,600 \$
1615	KSNHCL-015	16 mm	H - Class Makaron 1,5 KV	50	200	2,260 \$
1616	KSNHCL-016	18 mm	H - Class Makaron 1,5 KV	50	200	2,700 \$
1617	KSNHCL-017	20 mm	H - Class Makaron 1,5 KV	50	200	4,000 \$
1618	KSNHCL-018	25 mm	H - Class Makaron 1,5 KV	25	125	6,500 \$
1619	KSNHCL-019	30 mm	H - Class Makaron 1,5 KV	25	100	9,500 \$
1620	KSNHCL-020	35 mm	H - Class Makaron 1,5 KV	25	100	12,500 \$
1621	KSNHCL-021	40 mm	H - Class Makaron 1,5 KV	25	100	17,000 \$
1622	KSNHCL-022	50 mm	H - Class Makaron 1,5 KV	25	75	37,000 \$

KSN® H - CLASS SİLİKONLU MAKARONLAR**4 kV****İTHALATIMIZ**

SİPARİŞ KODU	ÜRÜN KODU	CİNSİ		RULO (m)	KOLİ MİKTARI (m)	FİYAT (\$) (m)
1645	KSNHCL-045	0,8 mm	H - Class Makaron 4 KV	100	1.500	- \$
1646	KSNHCL-046	1 mm	H - Class Makaron 4 KV	100	1.500	0,350 \$
1647	KSNHCL-047	1,5 mm	H - Class Makaron 4 KV	100	1.500	- \$
1648	KSNHCL-048	2 mm	H - Class Makaron 4 KV	100	1.000	0,400 \$
1649	KSNHCL-049	2,5 mm	H - Class Makaron 4 KV	100	1.000	0,500 \$
1650	KSNHCL-050	3 mm	H - Class Makaron 4 KV	100	600	0,560 \$
1651	KSNHCL-051	4 mm	H - Class Makaron 4 KV	100	500	0,700 \$
1652	KSNHCL-052	5 mm	H - Class Makaron 4 KV	100	500	0,850 \$
1653	KSNHCL-053	6 mm	H - Class Makaron 4 KV	100	500	1,000 \$
1654	KSNHCL-054	7 mm	H - Class Makaron 4 KV	100	500	1,200 \$
1655	KSNHCL-055	8 mm	H - Class Makaron 4 KV	100	400	1,400 \$
1656	KSNHCL-056	10 mm	H - Class Makaron 4 KV	100	400	1,700 \$
1657	KSNHCL-057	12 mm	H - Class Makaron 4 KV	50	250	2,200 \$
1658	KSNHCL-058	14 mm	H - Class Makaron 4 KV	50	250	3,000 \$
1659	KSNHCL-059	16 mm	H - Class Makaron 4 KV	50	200	3,500 \$
1660	KSNHCL-060	18 mm	H - Class Makaron 4 KV	50	200	7,800 \$
1661	KSNHCL-061	20 mm	H - Class Makaron 4 KV	50	200	8,000 \$
1662	KSNHCL-062	25 mm	H - Class Makaron 4 KV	25	125	11,000 \$
1663	KSNHCL-063	30 mm	H - Class Makaron 4 KV	25	100	19,000 \$
1664	KSNHCL-064	35 mm	H - Class Makaron 4 KV	25	100	25,000 \$
1665	KSNHCL-065	40 mm	H - Class Makaron 4 KV	25	100	33,000 \$
1666	KSNHCL-066	50 mm	H - Class Makaron 4 KV	25	75	65,000 \$

KSN® CAM ELYAF MAKARONLAR

2,5 kV

İTHALATIMIZ

SİPARİŞ KODU	ÜRÜN KODU	CİNSİ		RULO (m)	FİYAT (\$) (m)
1701	KSNCAM-001	0,8 mm	Cam Elyaf Makaron 2,5 KV	200	0,064 \$
1702	KSNCAM-002	1 mm	Cam Elyaf Makaron 2,5 KV	200	0,064 \$
1703	KSNCAM-003	1,5 mm	Cam Elyaf Makaron 2,5 KV	100	0,084 \$
1704	KSNCAM-004	2 mm	Cam Elyaf Makaron 2,5 KV	100	0,094 \$
1705	KSNCAM-005	2,5 mm	Cam Elyaf Makaron 2,5 KV	100	0,113 \$
1706	KSNCAM-006	3 mm	Cam Elyaf Makaron 2,5 KV	100	0,125 \$
1707	KSNCAM-007	4 mm	Cam Elyaf Makaron 2,5 KV	100	0,170 \$
1708	KSNCAM-008	5 mm	Cam Elyaf Makaron 2,5 KV	100	0,280 \$
1709	KSNCAM-009	6 mm	Cam Elyaf Makaron 2,5 KV	100	0,300 \$
1710	KSNCAM-010	7 mm	Cam Elyaf Makaron 2,5 KV	100	0,370 \$
1711	KSNCAM-011	8 mm	Cam Elyaf Makaron 2,5 KV	100	0,400 \$
1712	KSNCAM-012	10 mm	Cam Elyaf Makaron 2,5 KV	100	0,630 \$
1713	KSNCAM-013	12 mm	Cam Elyaf Makaron 2,5 KV	50	0,760 \$
1714	KSNCAM-014	14 mm	Cam Elyaf Makaron 2,5 KV	50	0,810 \$
1715	KSNCAM-015	16 mm	Cam Elyaf Makaron 2,5 KV	50	1,100 \$
1716	KSNCAM-016	18 mm	Cam Elyaf Makaron 2,5 KV	50	1,480 \$
1717	KSNCAM-017	20 mm	Cam Elyaf Makaron 2,5 KV	25	1,700 \$
1718	KSNCAM-018	25 mm	Cam Elyaf Makaron 2,5 KV	25	3,400 \$
1719	KSNCAM-019	30 mm	Cam Elyaf Makaron 2,5 KV	25	3,850 \$
1720	KSNCAM-020	35 mm	Cam Elyaf Makaron 2,5 KV	25	7,300 \$



2,5 kV

TEKNİK ÖZELLİKLER
Malzeme:

PVC İzoleli Cam Elyaf Makaron

Çalışma Sıcaklığı:

-60 °C + 250 °C



KSN®
PVC CAM ELYAF MAKARON**2,5 kV****TEKNİK ÖZELLİKLER****Malzeme:**

PVC İzoleli Cam Elyaf Makaron

Çalışma Sıcaklığı:

-60 °C + 250 °C



RENK	SİPARİŞ KODU	CİNSİ	RULO (m)	FİYAT (\$) (m)
KIRMIZI	1730	1 mm Cam Elyaf Makaron 2,5 kV	200	0,064 \$
	1731	1,5 mm Cam Elyaf Makaron 2,5 kV	200	0,084 \$
	1732	2 mm Cam Elyaf Makaron 2,5 kV	200	0,094 \$
	1733	2,5 mm Cam Elyaf Makaron 2,5 kV	200	0,113 \$
	1734	3 mm Cam Elyaf Makaron 2,5 kV	100	0,125 \$
	1735	4 mm Cam Elyaf Makaron 2,5 kV	100	0,170 \$
	1736	5 mm Cam Elyaf Makaron 2,5 kV	100	0,280 \$
	1737	6 mm Cam Elyaf Makaron 2,5 kV	100	0,300 \$
MAVİ	1738	1 mm Cam Elyaf Makaron 2,5 kV	200	0,064 \$
	1739	1,5 mm Cam Elyaf Makaron 2,5 kV	200	0,084 \$
	1740	2 mm Cam Elyaf Makaron 2,5 kV	200	0,094 \$
	1741	2,5 mm Cam Elyaf Makaron 2,5 kV	200	0,113 \$
	1742	3 mm Cam Elyaf Makaron 2,5 kV	100	0,125 \$
	1743	4 mm Cam Elyaf Makaron 2,5 kV	100	0,170 \$
	1744	5 mm Cam Elyaf Makaron 2,5 kV	100	0,280 \$
	1745	6 mm Cam Elyaf Makaron 2,5 kV	100	0,300 \$
SARI	1746	1 mm Cam Elyaf Makaron 2,5 kV	200	0,064 \$
	1747	1,5 mm Cam Elyaf Makaron 2,5 kV	200	0,084 \$
	1748	2 mm Cam Elyaf Makaron 2,5 kV	200	0,094 \$
	1749	2,5 mm Cam Elyaf Makaron 2,5 kV	200	0,113 \$
	1750	3 mm Cam Elyaf Makaron 2,5 kV	100	0,125 \$
	1751	4 mm Cam Elyaf Makaron 2,5 kV	100	0,170 \$
	1752	5 mm Cam Elyaf Makaron 2,5 kV	100	0,280 \$
	1753	6 mm Cam Elyaf Makaron 2,5 kV	100	0,300 \$
YEŞİL	1754	1 mm Cam Elyaf Makaron 2,5 kV	200	0,064 \$
	1755	1,5 mm Cam Elyaf Makaron 2,5 kV	200	0,084 \$
	1756	2 mm Cam Elyaf Makaron 2,5 kV	200	0,094 \$
	1757	2,5 mm Cam Elyaf Makaron 2,5 kV	200	0,113 \$
	1758	3 mm Cam Elyaf Makaron 2,5 kV	100	0,125 \$
	1759	4 mm Cam Elyaf Makaron 2,5 kV	100	0,170 \$
	1760	5 mm Cam Elyaf Makaron 2,5 kV	100	0,280 \$
	1761	6 mm Cam Elyaf Makaron 2,5 kV	100	0,300 \$
SİYAH	1762	1 mm Cam Elyaf Makaron 2,5 kV	200	0,064 \$
	1763	1,5 mm Cam Elyaf Makaron 2,5 kV	200	0,084 \$
	1764	2 mm Cam Elyaf Makaron 2,5 kV	200	0,094 \$
	1765	2,5 mm Cam Elyaf Makaron 2,5 kV	200	0,113 \$
	1766	3 mm Cam Elyaf Makaron 2,5 kV	100	0,125 \$
	1767	4 mm Cam Elyaf Makaron 2,5 kV	100	0,170 \$
	1768	5 mm Cam Elyaf Makaron 2,5 kV	100	0,280 \$
	1769	6 mm Cam Elyaf Makaron 2,5 kV	100	0,300 \$

-duyar-
motorpompa®

Yenilikçi bina teknolojileri

KABLO BAĞLARI VE AKSESUARLAR

KSN®
KABLO BAĞLARI

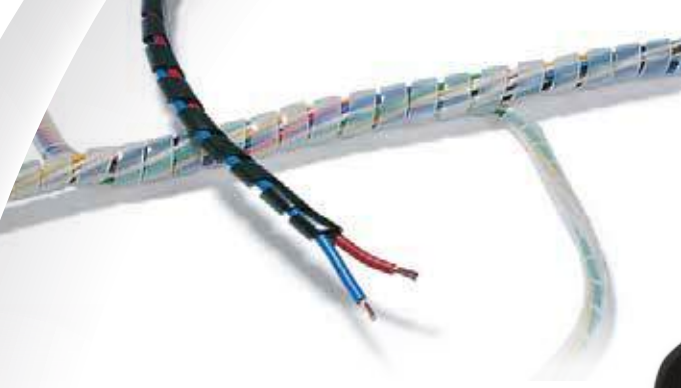



TEKNİK ÖZELLİKLER

Malzeme:

Naylon 6.6 Standart UL

Çalışma Sıcaklığı:

-40 °C + 85 °C

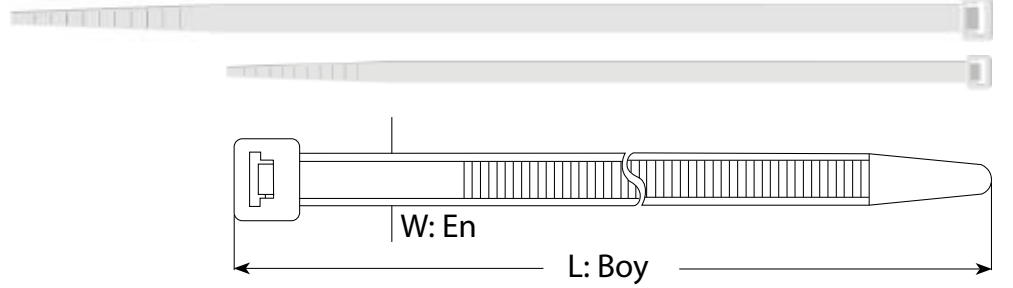

SİPARİŞ KODU	ÜRÜN KODU	Boyutlar		Renk	Azami Sıkma Çapı (mm)	Açılma Mukavemeti (Kg)	Poşet Miktarı	Koli Adedi	Birim Fiyat Adet (₺)
		Uzunluk (mm)	En (mm)						
2001	KCT - 100 M	100	2,5	Beyaz	20	8 KG	1.000	50.000	0,320 ₺
2002	KCT - 100 M	100		Beyaz	20		100	50.000	0,400 ₺
2003	KCT - 150 M	150		Beyaz	36		100	50.000	0,500 ₺
2004	KCT - 200 M	200		Beyaz	52		100	25.000	0,680 ₺
2005	KCT - 150 I	150	3,6	Beyaz	36	18 KG	100	20.000	0,790 ₺
2006	KCT - 200 I	200		Beyaz	52		100	20.000	1,040 ₺
2007	KCT - 250 I	250		Beyaz	68		100	20.000	1,270 ₺
2008	KCT - 300 I	300		Beyaz	78		100	15.000	1,560 ₺
2009	KCT - 370 I	370		Beyaz	106		100	10.000	1,950 ₺
2010	KCT - 200 ST	200	4,8	Beyaz	50	25 KG	100	10.000	1,470 ₺
2011	KCT - 250 ST	250		Beyaz	65		100	10.000	1,800 ₺
2012	KCT - 300 ST	300		Beyaz	81		100	10.000	2,250 ₺
2013	KCT - 370 ST	370		Beyaz	103		100	10.000	2,520 ₺
2014	KCT - 400 ST	400		Beyaz	113		100	5.000	3,000 ₺
2015	KCT - 430 ST	430		Beyaz	122		100	5.000	3,400 ₺
2016	KCT - 550 ST	550		Beyaz	160		100	5.000	4,950 ₺
2017	KCT - 300 HD	300	7,6	Beyaz	82	55 KG	100	5.000	4,650 ₺
2018	KCT - 370 HD	370		Beyaz	108		100	5.000	4,950 ₺
2019	KCT - 450 HD	450		Beyaz	130		100	2.500	5,500 ₺
2020	KCT - 550 HD	550		Beyaz	159		100	2.500	7,700 ₺
2021	KCT - 610 HD	610		Beyaz	181		100	2.000	9,200 ₺
2022	KCT - 750 HD	750		Beyaz	226		100	2.000	12,150 ₺
2067	KCT - 610 HD	610	9	Beyaz	182	80 KG	100	2.000	14,000 ₺
2023	KCT - 710 HD	710		Beyaz	195		100	2.000	14,500 ₺
2024	KCT - 760 HD	760		Beyaz	229		100	2.000	16,000 ₺
2025	KCT - 920 HD	920		Beyaz	280		100	1.000	18,500 ₺
2026	KCT - 1020 HD	1020		Beyaz	295		100	1.000	21,400 ₺
2027	KCT - 1220 HD	1220		Beyaz	375		100	1.000	26,000 ₺

KSN® SIYAH KABLO BAĞLARI

İTHALATIMIZ



TEKNİK ÖZELLİKLER

Malzeme:

Naylon 6.6 Standart UL

Çalışma Sıcaklığı:

-40 °C + 85 °C

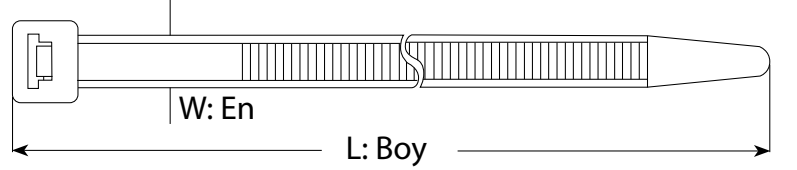

SİPARİŞ KODU	ÜRÜN KODU	Boyutlar		Renk	Azami Sıkma Çapı (mm)	Açılma Mukavemeti (Kg)	Poşet Miktarı	Koli Adedi	Birim Fiyat Adet (₺)
		Uzunluk (mm)	En (mm)						
2101	KCT - 100 MB	100	2,5	Siyah	20	8 KG	1.000	50.000	0,320 ₺
2102	KCT - 100 MB	100		Siyah	20		100	50.000	0,400 ₺
2103	KCT - 150 MB	150		Siyah	36		100	50.000	0,500 ₺
2104	KCT - 200 MB	200		Siyah	52		100	25.000	0,680 ₺
2105	KCT - 150 IB	150	3,6	Siyah	36	18 KG	100	20.000	0,790 ₺
2106	KCT - 200 IB	200		Siyah	52		100	20.000	1,040 ₺
2107	KCT - 250 IB	250		Siyah	68		100	20.000	1,270 ₺
2108	KCT - 300 IB	300		Siyah	78		100	15.000	1,560 ₺
2109	KCT - 370 IB	370		Siyah	106		100	10.000	1,950 ₺
2110	KCT - 200 STB	200	4,8	Siyah	50	25 KG	100	10.000	1,470 ₺
2111	KCT - 250 STB	250		Siyah	65		100	10.000	1,800 ₺
2112	KCT - 300 STB	300		Siyah	81		100	10.000	2,250 ₺
2113	KCT - 370 STB	370		Siyah	103		100	10.000	2,520 ₺
2114	KCT - 400 STB	400		Siyah	113		100	5.000	3,000 ₺
2115	KCT - 430 STB	430		Siyah	122		100	5.000	3,400 ₺
2116	KCT - 550 STB	550		Siyah	160		100	5.000	4,950 ₺
2117	KCT - 300 HDB	300	7,6	Siyah	82	55 KG	100	5.000	4,650 ₺
2118	KCT - 370 HDB	370		Siyah	108		100	5.000	4,950 ₺
2119	KCT - 450 HDB	450		Siyah	130		100	2.500	5,500 ₺
2120	KCT - 550 HDB	550		Siyah	159		100	2.500	7,700 ₺
2121	KCT - 610 HDB	610		Siyah	181		100	2.000	9,200 ₺
2122	KCT - 750 HDB	750		Siyah	226		100	2.000	12,150 ₺
2143	KCT - 610 HDB	610	9	Siyah	182	80 KG	100	2.000	14,000 ₺
2123	KCT - 710 HDB	710		Siyah	195		100	2.000	14,500 ₺
2124	KCT - 760 HDB	760		Siyah	229		100	2.000	16,000 ₺
2125	KCT - 920 HDB	920		Siyah	280		100	1.000	18,500 ₺
2126	KCT - 1020 HDB	1020		Siyah	295		100	1.000	21,400 ₺
2127	KCT - 1220 HDB	1220	Siyah	375	100	1.000	26,000 ₺		

KSN® RENKLİ KABLO BAĞLARI

İTHALATIMIZ

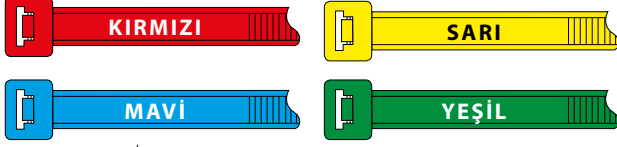

TEKNİK ÖZELLİKLER

Malzeme:

Naylon 6.6 Standart UL

Çalışma Sıcaklığı:

-40 °C + 85 °C

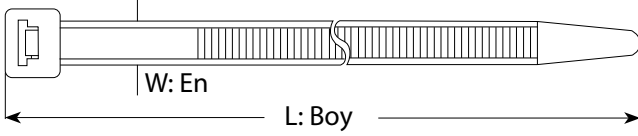

SİPARİŞ KODU	ÜRÜN KODU	Boyutlar		Renk	Azami Sıkma Çapı (mm)	Açılma Mukavemeti (Kg)	Poşet Miktarı	Koli Adedi	Birim Fiyat Adet (₺)
		Uzunluk (mm)	En (mm)						
2201	KCT - 100 M	100	2,5	● Kırmızı	20	8 KG	1.000	50.000	0,360 ₺
2202	KCT - 150 I	150	3,6	● Kırmızı	36	18 KG	100	20.000	0,870 ₺
2203	KCT - 200 I	200		● Kırmızı	52		100	20.000	1,150 ₺
2204	KCT - 250 I	250		● Kırmızı	68		100	20.000	1,400 ₺
2205	KCT - 300 I	300		● Kırmızı	78		100	15.000	1,750 ₺
2206	KCT - 200 ST	200		● Kırmızı	50		25 KG	100	10.000
2207	KCT - 250 ST	250	● Kırmızı	65	100	10.000		2,000 ₺	
2208	KCT - 300 ST	300	● Kırmızı	81	100	10.000		2,500 ₺	
2209	KCT - 370 ST	370	● Kırmızı	103	100	10.000		2,900 ₺	
2210	KCT - 430 ST	430	● Kırmızı	122	100	5.000		5,200 ₺	
2211	KCT - 370 HD	370	7,6	● Kırmızı	108	55 KG	100	5.000	7,950 ₺
2212	KCT - 100 M	100	2,5	● Sarı	20	8 KG	1.000	50.000	0,360 ₺
2213	KCT - 150 I	150	3,6	● Sarı	36	18 KG	100	20.000	0,870 ₺
2214	KCT - 200 I	200		● Sarı	52		100	20.000	1,150 ₺
2215	KCT - 250 I	250		● Sarı	68		100	20.000	1,400 ₺
2216	KCT - 300 I	300		● Sarı	78		100	15.000	1,750 ₺
2217	KCT - 200 ST	200		● Sarı	50		25 KG	100	10.000
2218	KCT - 250 ST	250	● Sarı	65	100	10.000		2,000 ₺	
2219	KCT - 300 ST	300	● Sarı	81	100	10.000		2,500 ₺	
2220	KCT - 370 ST	370	● Sarı	103	100	10.000		2,900 ₺	
2221	KCT - 430 ST	430	● Sarı	122	100	5.000		5,200 ₺	
2222	KCT - 370 HD	370	7,6	● Sarı	108	55 KG	100	5.000	7,950 ₺
2223	KCT - 100 M	100	2,5	● Mavi	20	8 KG	1.000	50.000	0,360 ₺
2224	KCT - 150 I	150	3,6	● Mavi	36	18 KG	100	20.000	0,870 ₺
2225	KCT - 200 I	200		● Mavi	52		100	20.000	1,150 ₺
2226	KCT - 250 I	250		● Mavi	68		100	20.000	1,400 ₺
2227	KCT - 300 I	300		● Mavi	78		100	15.000	1,750 ₺
2228	KCT - 200 ST	200		● Mavi	50		25 KG	100	10.000
2229	KCT - 250 ST	250	● Mavi	65	100	10.000		2,000 ₺	
2230	KCT - 300 ST	300	● Mavi	81	100	10.000		2,500 ₺	
2231	KCT - 370 ST	370	● Mavi	103	100	10.000		2,900 ₺	
2232	KCT - 430 ST	430	● Mavi	122	100	5.000		5,200 ₺	
2233	KCT - 370 HD	370	7,6	● Mavi	108	55 KG	100	5.000	7,950 ₺
2234	KCT - 100 M	100	2,5	● Yeşil	20	8 KG	1.000	50.000	0,360 ₺
2235	KCT - 150 I	150	3,6	● Yeşil	36	18 KG	100	20.000	0,870 ₺
2236	KCT - 200 I	200		● Yeşil	52		100	20.000	1,150 ₺
2237	KCT - 250 I	250		● Yeşil	68		100	20.000	1,400 ₺
2238	KCT - 300 I	300		● Yeşil	78		100	15.000	1,750 ₺
2239	KCT - 200 ST	200		● Yeşil	50		25 KG	100	10.000
2240	KCT - 250 ST	250	● Yeşil	65	100	10.000		2,000 ₺	
2241	KCT - 300 ST	300	● Yeşil	81	100	10.000		2,500 ₺	
2242	KCT - 370 ST	370	● Yeşil	103	100	10.000		2,900 ₺	
2243	KCT - 430 ST	430	● Yeşil	122	100	5.000		5,200 ₺	
2244	KCT - 370 HD	370	7,6	● Yeşil	108	55 KG	100	5.000	7,950 ₺

KSN® ETİKETLİ BEYAZ KABLO BAĞLARI

İTHALATIMIZ

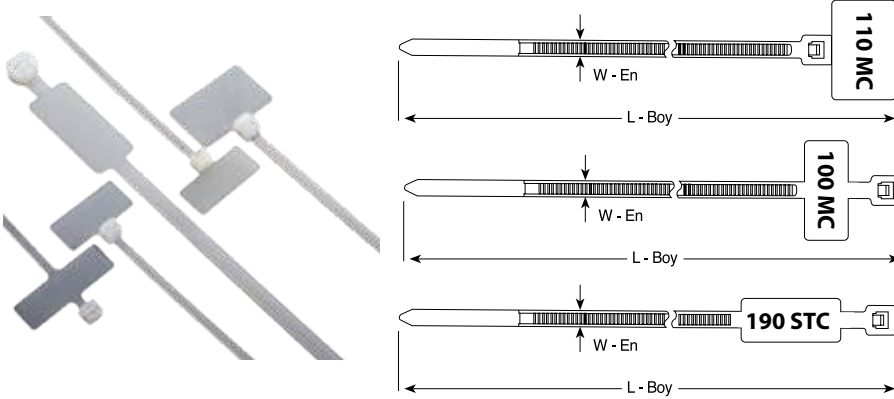

TEKNİK ÖZELLİKLER

Malzeme: Naylon 6.6 Standart UL
Çalışma Sıcaklığı: -40 °C + 85 °C

SİPARİŞ KODU	ÜRÜN KODU	Boy (mm)	En (mm)	Maksimum Bağlama Çapı	Açılma Mukavemeti (Kg)	Poşet Adedi	Koli Adedi	Birim Fiyat (₺)
2028	KCT-100 MC	100	2,5	22	8	100	20.000	1,150 ₺
2029	KCT-110 MC	110	2,5	22	8	100	20.000	1,700 ₺
2030	KCT-190 STC	190	4,8	50	22	100	10.000	2,700 ₺

KSN® PANELE KAFADAN SIKIŞAN BEYAZ KABLO BAĞLARI

İTHALATIMIZ

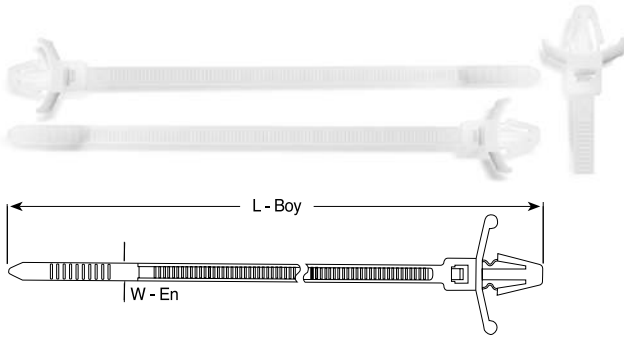

TEKNİK ÖZELLİKLER

Malzeme: Naylon 6.6 Standart UL
Çalışma Sıcaklığı: -40 °C + 85 °C

SİPARİŞ KODU	ÜRÜN KODU	Boy (mm)	En (mm)	Maksimum Bağlama Çapı	Açılma Mukavemeti (Kg)	Poşet Adedi	Koli Adedi	Birim Fiyat (₺)
2031	KCT-PT 100 M	100	2,5	20	8	100	25.000	1,100 ₺
2032	KCT-PT 150 I	150	3,6	35	18	100	20.000	1,550 ₺
2033	KCT-PT 200 ST	200	4,8	50	23	100	10.000	3,200 ₺

KSN® AÇILABİLİR BEYAZ KABLO BAĞLARI

İTHALATIMIZ

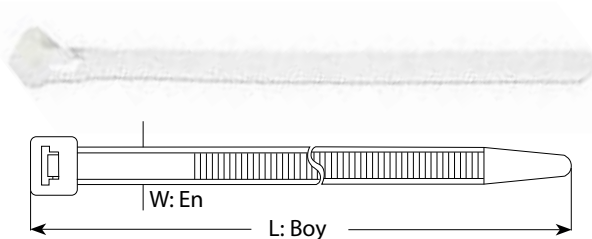

TEKNİK ÖZELLİKLER

Malzeme: Naylon 6.6 Standart UL
Çalışma Sıcaklığı: -40 °C + 85 °C

SİPARİŞ KODU	ÜRÜN KODU	Boy (mm)	En (mm)	Maksimum Bağlama Çapı	Açılma Mukavemeti (Kg)	Poşet Adedi	Koli Adedi	Birim Fiyat (₺)
2034	KCT-SHA 250 HD	250	7,6	60	22	100	5.000	3,700 ₺
2035	KCT-SHA 370 HD	370	7,6	100	22	100	3.000	6,000 ₺

KSN® 304 PASLANMAZ ÇELİK KABLO BAĞLARI

İTHALATIMIZ

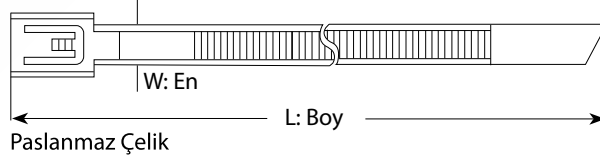

TEKNİK ÖZELLİKLER

Malzeme: 304 Paslanmaz Çelik
Su Emilimi: Yok
Alev Yürümeme: UL94V-2
UV Dayanıklılığı: Mükemmel
Kimyasal Dayanıklılık: Mükemmel
Çalışma Sıcaklığı: -80 °C + 538 °C

SİPARİŞ KODU	ÜRÜN KODU	L	W	Maksimum Bağlama Çapı	Açılma Mukavemeti (Kg)	Poşet Adedi	Koli Adedi	Birim Fiyat
2301	K-MTL-150 ST	150	4.6	46	65	100	5.000	5,300 ₺
2302	K-MTL-200 ST	200		61	65		5.000	5,600 ₺
2303	K-MTL-260 ST	260		81	65		5.000	6,600 ₺
2304	K-MTL-300 ST	300		90	65		5.000	7,200 ₺
2305	K-MTL-370 ST	370		112	65		4.000	8,200 ₺
2306	K-MTL-450 ST	450		130	65		4.000	10,000 ₺
2307	K-MTL-520 ST	520		163	65		3.000	10,500 ₺
2308	K-MTL-680 ST	680		214	65		2.000	12,900 ₺
2309	K-MTL-840 ST	840		265	65		1.000	15,200 ₺
2310	K-MTL-200 HD	200	7.9	61	130	100	5.000	9,600 ₺
2311	K-MTL-300 HD	300		90	130		4.000	11,800 ₺
2312	K-MTL-370 HD	370		112	130		3.000	13,700 ₺
2313	K-MTL-450 HD	450		130	130		4.000	15,500 ₺
2314	K-MTL-520 HD	520		163	130		2.000	17,500 ₺
2315	K-MTL-680 HD	680		214	130		2.000	20,800 ₺
2316	K-MTL-840 HD	840		265	130		1.000	24,300 ₺

KSN® 304 PASLANMAZ ÇELİK ETİKET

İTHALATIMIZ

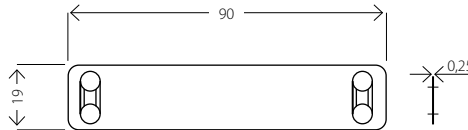

TEKNİK ÖZELLİKLER

Malzeme: 304 Paslanmaz Çelik
Su Emilimi: Yok
Alev Yürümeme: UL94V-2
UV Dayanıklılığı: Mükemmel
Kimyasal Dayanıklılık: Mükemmel
Çalışma Sıcaklığı: -80 °C + 538 °C

SİPARİŞ KODU	ÜRÜN KODU	ÜRÜN AÇIKLAMASI	Renk	Boy ve Genişlik (mm)	Ambalaj Adedi	Koli Adedi	Birim Fiyat
2317	K-MTL-ETK	Paslanmaz Çelik Etiket	Metal	19 x 90 mm	100	5.000	12,350 ₺

Paslanmaz Çelik Kablo Bağları

- Kendiliğinden kilitlenebilir kafa tasarımı, kurulumu hızlandırır ve kablo bağı gövdesi boyunca herhangi bir boyda kilitlemeyi sağlar.
- Güçlü ve dayanıklı kablo bağlama yöntemini temin eder.
- Çok çeşitli iç mekân ve dış mekân uygulama alanlarında kullanılabilir.
- Pürüzsüz yüzeyi ve yuvarlatılmış uçları ile kablonun korunmasını ve çalışan kişinin güvenliğini garanti eder.
- Şebeke kablolarında en üst düzey desteği sağlar.
- Genel amaçlı uygulamalar için : 304 paslanmaz çelik

KSN® 304 PASLANMAZ ÇELİK POLYESTER KAPLI KABLO BAĞLARI

İTHALATIMIZ

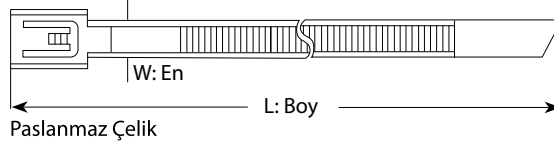

TEKNİK ÖZELLİKLER

- Malzeme:** 304 Paslanmaz Çelik
- Su Emilimi:** Yok
- Alev Yürümeme:** UL94V-2
- UV Dayanıklılığı:** Mükemmel
- Kimyasal Dayanıklılık:** Mükemmel
- Çalışma Sıcaklığı:** -40 °C + 150 °C

SİPARİŞ KODU	ÜRÜN KODU	L	W	Maksimum Bağlama Çapı	Açılma Mukavemeti (Kg)	Poşet Adedi	Koli Adedi	Birim Fiyat
2401	K-PMTL-150 ST	150	4.6	46	65	100	5.000	7,000 ₺
2402	K-PMTL-200 ST	200		61	65		5.000	7,800 ₺
2403	K-PMTL-260 ST	260		81	65		5.000	8,700 ₺
2404	K-PMTL-300 ST	300		90	65		5.000	9,600 ₺
2405	K-PMTL-370 ST	370		112	65		4.000	11,500 ₺
2406	K-PMTL-520 ST	520		163	65		3.000	15,000 ₺
2407	K-PMTL-680 ST	680		214	65		2.000	18,500 ₺
2408	K-PMTL-840 ST	840		265	65		1.000	23,500 ₺
2409	K-PMTL-200 HD	200	7.9	61	130	100	5.000	12,000 ₺
2410	K-PMTL-300 HD	300		90	130		4.000	15,200 ₺
2411	K-PMTL-370 HD	370		112	130		3.000	17,700 ₺
2412	K-PMTL-520 HD	520		163	130		2.000	23,200 ₺
2413	K-PMTL-680 HD	680		214	130		2.000	28,400 ₺
2414	K-PMTL-840 HD	840		265	130		1.000	33,500 ₺

Paslanmaz Çelik Kablo Bağları

- Kendiliğinden kilitlenebilir kafa tasarımı, kurulumu hızlandırır ve kablo bağı gövdesi boyunca herhangi bir boyda kilitlemeyi sağlar.
- Güçlü ve dayanıklı kablo bağlama yöntemini temin eder.
- Çok çeşitli iç mekân ve dış mekân uygulama alanlarında kullanılabilir.
- Pürüzsüz yüzeyi ve yuvarlatılmış uçları ile kablunun korunmasını ve çalışan kişinin güvenliğini garanti eder.
- Şebeke kablolarında en üst düzey desteği sağlar.
- Genel amaçlı uygulamalar için : 304 paslanmaz çelik
- Polyester kaplıdır.

KSN® TIRNAKLI KABLO BAĞI

İTHALATIMIZ



SİPARİŞ KODU	ÜRÜN KODU	L (mm)	W (mm)	Poşet Adedi	Koli Adedi	Birim Fiyat (₺)
2128	KCT-200 ECT	200	4,8	100	5.000	11,250 ₺

Tırnaklı Kablo Bağı Aparatı

- Kablo bağlama kafası paketlemeden sonra hareket ettirilebilir.
- Otomotiv endüstrisinde kablo, boru ve hortumların sabitlenmesi ve demonte edilmesi, kablo demeti yapımı, panel yapımı ve elektrik endüstrisinde yaygın olarak kullanılmaktadır.

Malzeme

- Poliamid 6.6 UV ile stabilize edilmiş (PA66UV)
- Kablo Bağlantıları: Polyamide 6.6, ısıya dayanıklı (PA66HS)
- Ayak bölümü: Polyamid 6.6, yüksek darbe tadil edilmiş, ısıya dayanıklı (PA66HIRHS)

Operasyon Sıcaklığı

- Polyamid 6.6 UV ile stabilize edilmiş (PA66UV): -40 °C ila + 85 °C
- Isıya dayanıklı (PA66HS): -40 °C ila + 115 °C



KSN® YAPIŞKANLI KROŞELER

İTHALATIMIZ

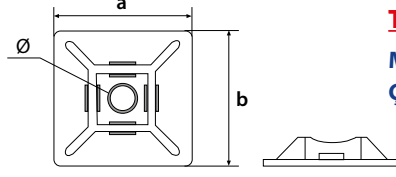

TEKNİK ÖZELLİKLER

Malzeme: Naylon 6.6 Standart UL
Çalışma Sıcaklığı: -40 °C + 85 °C

SİPARİŞ KODU	ÜRÜN KODU	a (mm)	b (mm)	Delik Çapı (mm)	Maksimum Kablo Bağı Eni (mm)	Renk	Poşet Adedi	Koli Adedi	Birim Fiyat (₺)
2036	KCT-HW 3A	19	19	Ø 3,2	3,6	Beyaz	100	5.000	1,750 ₺
2037	KCT-HW 4A	28	28	Ø 3,2	4,8	Beyaz	100	5.000	3,200 ₺
2129	KCT-HW 3AB	19	19	Ø 4,3	3,6	Siyah	100	5.000	1,750 ₺
2130	KCT-HW 4AB	28	28	Ø 4,3	4,8	Siyah	100	5.000	3,200 ₺

KSN® VİDALI KROŞE

İTHALATIMIZ

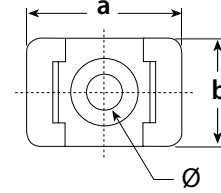

TEKNİK ÖZELLİKLER

Malzeme: Naylon 6.6 Standart UL
Çalışma Sıcaklığı: -40 °C + 85 °C

SİPARİŞ KODU	ÜRÜN KODU	a (mm)	b (mm)	Delik Çapı (mm)	Maksimum Kablo Bağı Eni (mm)	Renk	Poşet Adedi	Koli Adedi	Birim Fiyat (₺)
2038	KCT-VK 1	15	10	Ø 5	3,6	Beyaz	100	5.000	1,300 ₺
2039	KCT-VK 2	23	16	Ø 10	7,6	Beyaz	100	5.000	1,950 ₺
2131	KCT-VK 1B	15	10	Ø 5	3,6	Siyah	100	5.000	1,300 ₺
2132	KCT-VK 2B	23	16	Ø 10	7,6	Siyah	100	5.000	1,950 ₺

KSN® YAPIŞKANLI KABLO TUTUCU

İTHALATIMIZ

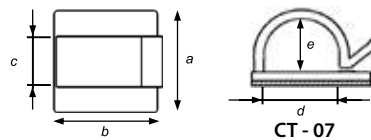

TEKNİK ÖZELLİKLER

Malzeme: Naylon 6.6 Standart UL
Çalışma Sıcaklığı: -40 °C + 85 °C

SİPARİŞ KODU	ÜRÜN KODU	A	B	C	D	MAX. BAĞLAMA GENİŞLİĞİ (E)	Koli Adedi	Birim Fiyat (₺)
2141	KCT-KT 12	25	25	12,7	12,5	8	5.000	6,370 ₺
2142	KCT-KT 15	25	25	12,7	16,5	12	5.000	8,000 ₺

KSN® KABLO KLİPSİ

İTHALATIMIZ

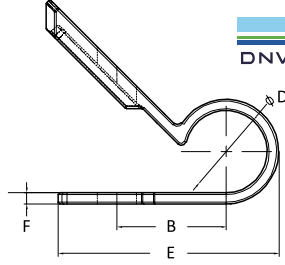

TEKNİK ÖZELLİKLER

Malzeme: Naylon 6.6 Standart UL
Çalışma Sıcaklığı: -40 °C + 185 °C

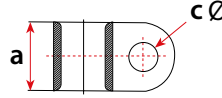

SİPARİŞ KODU	ÜRÜN KODU	a (mm)	E (mm)	c (mm)	D (mm)	F (mm)	Poşet Adedi	Koli Adedi	Birim Fiyat (₺)
2040	KPKL-03	9,6	16,9	4	3,0 (1/8")	1,2	100	20.000	0,960 ₺
2041	KPKL-05	9,6	18,5	4	5,3 (3/16")	1,2	100	20.000	0,980 ₺
2042	KPKL-06	10,1	20	4	6,8 (1/4")	1,2	100	15.000	1,150 ₺
2043	KPKL-08	10	22,6	4	8,4 (5/16")	1,2	100	10.000	1,450 ₺
2044	KPKL-10	12,3	26,6	5	10,8 (3/8")	1,4	100	6.000	1,700 ₺
2045	KPKL-13	12,2	30,3	5	13,8 (1/2")	1,4	100	9.000	2,340 ₺
2046	KPKL-16	12,4	32,6	5	17,4 (5/8")	1,4	100	8.000	3,250 ₺
2047	KPKL-19	11,8	37,3	5	19,9 (3/4")	1,4	100	6.000	3,500 ₺
2048	KPKL-25	12	43,4	5	27,2 (1")	1,4	100	4.500	4,160 ₺
2049	KPKL-32	12	52,3	5	33,8 (1 1/4")	1,6	100	3.000	5,350 ₺
2050	KPKL-38	12,5	58,3	5	41,9 (1 1/2")	1,5	100	2.500	6,240 ₺

KSN® DÜBEL KROŞE

İTHALATIMIZ

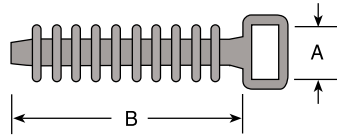

TEKNİK ÖZELLİKLER

Malzeme: Naylon 6.6 Standart UL
Çalışma Sıcaklığı: -40 °C + 85 °C

SİPARİŞ KODU	ÜRÜN KODU	a (mm)	b (mm)	Delik Çapı (mm)	Maksimum Kablo Bağı Eni (mm)	Poşet Adedi	Koli Adedi	Birim Fiyat (₺)
2139	KCT-TH 2	10,6	43,6	Ø 10,3	9	100	5.000	2,250 ₺

KSN® BASKILI DEVRE TAŞIYICILARI

İTHALATIMIZ

TEKNİK ÖZELLİKLER

Malzeme: Naylon 6.6 Standart UL
Çalışma Sıcaklığı: -40 °C + 85 °C

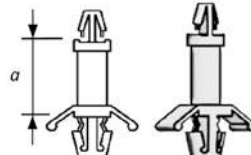

KSN-70-1070

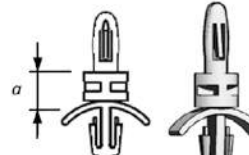

KSN-08-1008

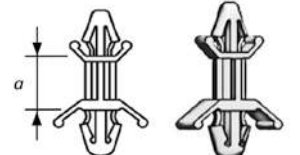

KSN-71-1071



KSN-72-1072

SİPARİŞ KODU	ÜRÜN KODU	Yükseklik (mm)	Genişlik (mm)	Üst Delik Çapı (mm)	Alt Delik Çapı (mm)	a (mm)	Poşet Adedi	Koli Adedi	Birim Fiyat (₺)
2051	KSN-08-1008	24,5	15	Ø 4	Ø 4,5	6,2	500	40.000	4,000 ₺
2052	KSN-70-1070	27	14,4	Ø 3	Ø 4,8	13,9	250	35.000	2,000 ₺
2053	KSN-71-1071	26,5	15,3	Ø 4	Ø 4,8	9,2	250	40.000	2,000 ₺
2054	KSN-72-1072	30	15,3	Ø 4	Ø 4,8	12,6	250	35.000	2,100 ₺

KSN® YAPIŞKANLI BÜKÜLEBİLİR KLİPS

İTHALATIMIZ

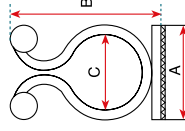

TEKNİK ÖZELLİKLER

Malzeme: Naylon 6.6 Standart UL
Çalışma Sıcaklığı: -40 °C + 85 °C



SİPARİŞ KODU	ÜRÜN KODU	A	B	C	Poşet Adedi	Birim Fiyat (₺)
2055	KSN-8435	20 x 20	32	16	100	34,000 ₺

KSN® KABLO BAĞI ETİKET TAŞIYICI

İTHALATIMIZ



TEKNİK ÖZELLİKLER

Malzeme: Naylon 6.6 Standart UL
Çalışma Sıcaklığı: -40 °C + 85 °C



SİPARİŞ KODU	ÜRÜN KODU	Boy (mm)	Genişlik (mm)	Poşet Adedi	Koli Adedi	Birim Fiyat (₺)
2056	KCT-ET 07 907	10	35	100	12.500	3,350 ₺
2057	KCT-ET 06 906	20	45	100	6.000	6,700 ₺

KSN® YAPIŞKAN PANO ETİKETİ

İTHALATIMIZ

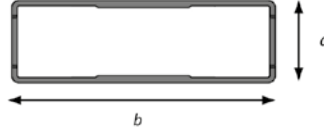

TEKNİK ÖZELLİKLER

Malzeme: Naylon 6.6 Standart UL
Çalışma Sıcaklığı: -40 °C + 85 °C



SİPARİŞ KODU	ÜRÜN KODU	a (mm)	b (mm)	Etiket Boyu (mm)	Etiket Eni (mm)	Poşet Adedi	Koli Adedi	Birim Fiyat (₺)
2058	KSN-08-908	17	30	14,4	27,5	100	12.000	4,300 ₺
2059	KSN-03-903	17	50	15	49	50	6.000	6,000 ₺
2060	KSN-04-904	17	75	15	72	25	5.000	7,800 ₺

KSN® KAPAMA PARÇASI

İTHALATIMIZ



TEKNİK ÖZELLİKLER

Malzeme: Bakır, Kalay kaplı
İzolasyon: Naylon 6.6 Standart, UL 94 / V2 normu
Çalışma Sıcaklığı: Maksimum 105 °C 300 Volt
Diğer Özellikler: (CE - 8) Modeli 600 Volt enerjiye dayanabilme özelliğine sahiptir.

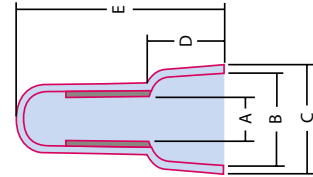

SİPARİŞ KODU	ÜRÜN KODU	Ölçüler (mm)					Kutu Adedi	Birim Fiyat (₺)
		A	B	C	D	E		
2416	CE-1	2.6	6.2	7.8	6.0	18.0	1000	0,480 ₺
2417	CE-2	3.1	7.9	9.5	7.0	20.0	1000	0,500 ₺
2415	CE-3	4.0	8.8	10.3	7.5	21.5	1000	1,000 ₺
2418	CE-5	4.4	10.5	12.5	9.6	25.5	1000	1,300 ₺
2419	CE-8	5.3	12.4	14.3	12.0	27.7	500	3,300 ₺

KSN® HELEZON KABLO SİRALLERİ

İTHALATIMIZ

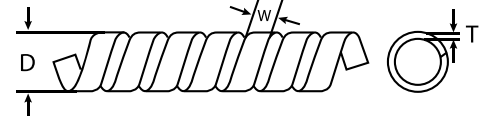
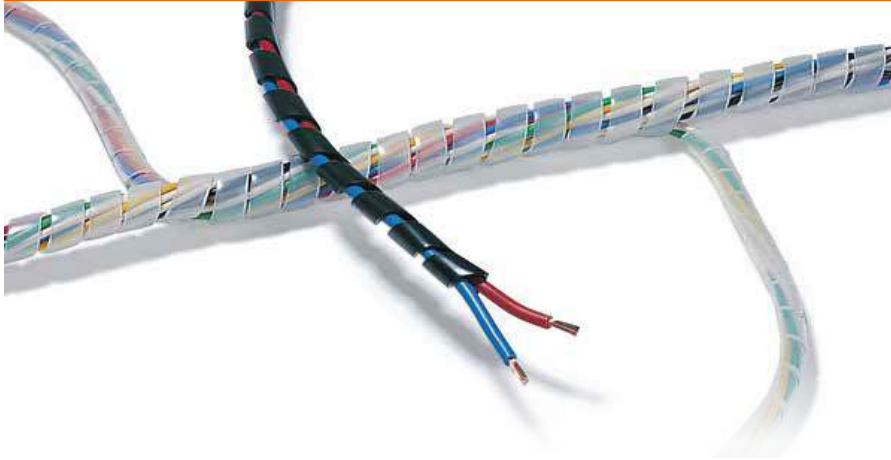

SİPARİŞ KODU	ÜRÜN KODU	Ölçüler (mm)				Kablo Kesit (mm ²)	Renk	Paket Miktarı (m)	Koli Miktarı (m)	Metre Fiyatı (₺)
		T	D	W						
2061	KSPR-06 (No1)	0,60	6	7,5	2,5 - 15	Beyaz	10	1000	9,000 ₺	
2062	KSPR-08 (No2)	0,75	8	12	6 - 30	Beyaz	10	800	14,000 ₺	
2063	KSPR-10 (No3)	0,80	10	12,5	7,5 - 30	Beyaz	10	500	21,600 ₺	
2064	KSPR-12 (No4)	0,85	12	15	9 - 32	Beyaz	10	400	30,100 ₺	
2065	KSPR-15 (No5)	1,00	15	15,5	12 - 35	Beyaz	10	250	44,200 ₺	
2066	KSPR-19 (No6)	1,00	19	18	22 - 50	Beyaz	10	100	68,000 ₺	
2133	KSPR-06 B (No1)	0,60	6	7,5	2,5 - 15	Siyah	10	1000	9,000 ₺	
2134	KSPR-08 B (No2)	0,75	8	12	6 - 30	Siyah	10	800	14,000 ₺	
2135	KSPR-10 B (No3)	0,80	10	12,5	7,5 - 30	Siyah	10	500	21,600 ₺	
2136	KSPR-12 B (No4)	0,85	12	15	9 - 32	Siyah	10	400	30,100 ₺	
2137	KSPR-15 B (No5)	1,00	15	15,5	12 - 35	Siyah	10	250	44,200 ₺	
2138	KSPR-19 B (No6)	1,00	19	18	22 - 50	Siyah	10	100	68,000 ₺	

TEKNİK ÖZELLİKLER

Malzeme: PE

Çalışma Sıcaklığı: -20 °C + 65 °C

Özellikler: Esnek yapısı sayesinde kabloları düzenlenmesine yardımcı olur. Güçlü yapısı sayesinde tekrar kullanıma uygundur.

KSN® EC TİPİ KABLO İŞARETLEME

İTHALATIMIZ

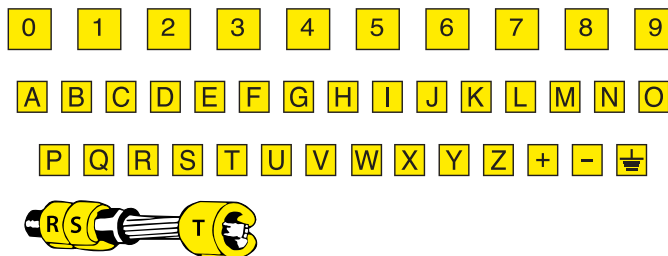

Kabloya yandan geçmeli,
montajdan önce takılabilen

SİPARİŞ KODU	ÜRÜN KODU	AÇIKLAMA	KABLO KESİTİ	MAKARA MİKTARI	Birim Fiyat (₺)
2420	EC 0	Kablo İşaretleme	0,50 x 1,5 mm ²	1.000	135,000 ₺
2421	EC 1	Kablo İşaretleme	1,50 x 6,0 mm ²	1.000	135,000 ₺
2422	EC 2	Kablo İşaretleme	4,0 x 16,00 mm ²	500	135,000 ₺

KABLO YÜKSÜKLERİ VE PAPUÇLARI

-duyar-
motorpompa®

Yenilikçi bina teknolojileri

KSN®
KABLO UÇLARI



KSN® İZOLELİ TEK GİRİŞ YÜKSÜKLER

FRANSIZ NORMU

İTHALATIMIZ

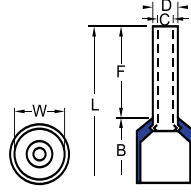















TEKNİK ÖZELLİKLER

Standart: DIN46228

Malzeme: Bakır, kalay kaplı

İzolasyon: Naylon

Çalışma Sıcaklığı: Maksimum 105 °C, 600 Volt arası

SİPARİŞ KODU	ÜRÜN KODU	TANIM	KESİT	BOYUTLAR		FRANSIZ RENK		KUTU ADEDİ	BİRİM FİYATI ₺
				F	L				
3001	KSN-İY-0001	K-3002	0,25mm ²	8	12		Mor	1.000	1,150 ₺
3002	KSN-İY-0002	K-3003	0,34 mm ²	8	12		Pembe	1.000	1,150 ₺
3003	KSN-İY-0003	K-3005	0,50 mm ²	8	12		Beyaz	1.000	0,530 ₺
3004	KSN-İY-0004	K-3007	0,75 mm ²	8	14		Mavi	1.000	0,530 ₺
3005	KSN-İY-0005	K-3010	1,00 mm ²	8	14		Kırmızı	1.000	0,530 ₺
3006	KSN-İY-0006	K-3015	1,50 mm ²	8	14		Siyah	1.000	0,590 ₺
3007	KSN-İY-0007	K-3025	2,50 mm ²	8	14		Gri	500	0,750 ₺
3008	KSN-İY-0008	K-3040	4,00 mm ²	10	17		Turuncu	500	1,270 ₺
3009	KSN-İY-0009	K-3060	6,00 mm ²	12	20		Yeşil	250	1,760 ₺
3010	KSN-İY-0010	K-3100	10,00 mm ²	12	22		Kahve	100	2,200 ₺
3011	KSN-İY-0011	K-3160	16,00 mm ²	12	24		Bej	100	3,100 ₺
3012	KSN-İY-0012	K-3250	25,00 mm ²	16	28		Siyah	50	5,000 ₺
3013	KSN-İY-0013	K-3350	35,00 mm ²	16	30		Kırmızı	50	6,400 ₺
3014	KSN-İY-0014	K-3500	50,00 mm ²	20	36		Mavi	25	12,000 ₺
3015	KSN-İY-0015	K-3700	70,00 mm ²	20	37		Sarı	25	22,000 ₺



KSN®
KABLO UÇLARI

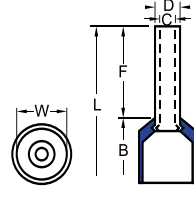

TEKNİK ÖZELLİKLER

Standart: DIN46228

Malzeme: Bakır, kalay kaplı

İzolasyon: Naylon

Çalışma Sıcaklığı: Maksimum 105 °C, 600 Volt arası

SİPARİŞ KODU	ÜRÜN KODU	TANIM	KESİT	BOYUTLAR		ALMAN RENK	KUTU ADEDİ	BİRİM FİYATI ₺	
				F	L				
3030	KSN-İY-0016	K-2002	0,25mm ²	8	12		Turkuaz	1.000	1,150 ₺
3031	KSN-İY-0017	K-2003	0,34 mm ²	8	12		Turkuaz	1.000	1,150 ₺
3032	KSN-İY-0018	K-2005	0,50 mm ²	8	12		Turuncu	1.000	0,530 ₺
3033	KSN-İY-0019	K-2007	0,75 mm ²	8	14		Beyaz	1.000	0,530 ₺
3034	KSN-İY-0020	K-2010	1,00 mm ²	8	14		Sarı	1.000	0,530 ₺
3035	KSN-İY-0021	K-2015	1,50 mm ²	8	14		Kırmızı	1.000	0,590 ₺
3036	KSN-İY-0022	K-2025	2,50 mm ²	8	14		Mavi	500	0,750 ₺
3037	KSN-İY-0023	K-2040	4,00 mm ²	10	17		Gri	500	1,270 ₺
3038	KSN-İY-0024	K-2060	6,00 mm ²	12	20		Siyah	250	1,760 ₺
3039	KSN-İY-0025	K-2100	10,00 mm ²	12	22		Bej	100	2,200 ₺
3040	KSN-İY-0026	K-2160	16,00 mm ²	12	24		Yeşil	100	3,100 ₺
3041	KSN-İY-0027	K-2250	25,00 mm ²	16	28		Kahve	50	5,000 ₺
3042	KSN-İY-0028	K-2350	35,00 mm ²	16	30		Bej	50	6,400 ₺
3043	KSN-İY-0029	K-2500	50,00 mm ²	20	36		Yeşil	25	12,000 ₺
3044	KSN-İY-0030	K-2700	70,00 mm ²	20	37		Sarı	25	22,000 ₺



KSN® İZOLELİ ÇİFT GİRİŞ YÜKSÜKLER
FRANSIZ NORMU

İTHALATIMIZ

TEKNİK ÖZELLİKLER

Standart: DIN46228

Malzeme: Bakır, kalay kaplı

İzolasyon: Naylon

Çalışma Sıcaklığı: Maksimum 105 °C, 600 Volt arası

SİPARİŞ KODU	ÜRÜN KODU	TANIM	KESİT	BOYUTLAR		FRANSIZ RENK	KUTU ADEDİ	BİRİM FİYATI ₺	
				F	L				
3050	KSN-İY-0031	K-23005	2 x 0,50 mm ²	8	14		Beyaz	1.000	0,950 ₺
3051	KSN-İY-0032	K-23007	2 x 0,75 mm ²	8	14		Mavi	500	1,000 ₺
3052	KSN-İY-0033	K-23010	2 x 1,00 mm ²	8	14		Kırmızı	500	1,050 ₺
3053	KSN-İY-0034	K-23015	2 x 1,50 mm ²	8	14		Siyah	500	1,300 ₺
3054	KSN-İY-0035	K-23025	2 x 2,50 mm ²	8	14		Gri	250	2,100 ₺
3055	KSN-İY-0036	K-23040	2 x 4,00 mm ²	10	17		Turuncu	200	2,450 ₺
3056	KSN-İY-0037	K-23060	2 x 6,00 mm ²	12	20		Yeşil	100	3,000 ₺
3057	KSN-İY-0038	K-23100	2 x 10,00 mm ²	12	27		Kahverengi	50	4,670 ₺
3058	KSN-İY-0039	K-23160	2 x 16,00 mm ²	12	31		Bej	50	6,000 ₺

KSN® İZOLELİ ÇİFT GİRİŞ YÜKSÜKLER
ALMAN NORMU

İTHALATIMIZ

TEKNİK ÖZELLİKLER

Standart: DIN46228

Malzeme: Bakır, kalay kaplı

İzolasyon: Naylon

Çalışma Sıcaklığı: Maksimum 105 °C, 600 Volt arası

SİPARİŞ KODU	ÜRÜN KODU	TANIM	KESİT	BOYUTLAR		ALMAN RENK	KUTU ADEDİ	BİRİM FİYATI ₺	
				F	L				
3070	KSN-İY-0040	K-22005	2 x 0,50 mm ²	8	14		Turuncu	1.000	0,950 ₺
3071	KSN-İY-0041	K-22007	2 x 0,75 mm ²	8	14		Beyaz	500	1,000 ₺
3072	KSN-İY-0042	K-22010	2 x 1,00 mm ²	8	14		Sarı	500	1,050 ₺
3073	KSN-İY-0043	K-22015	2 x 1,50 mm ²	8	14		Kırmızı	500	1,300 ₺
3074	KSN-İY-0044	K-22025	2 x 2,50 mm ²	8	14		Mavi	250	2,100 ₺
3075	KSN-İY-0045	K-22040	2 x 4,00 mm ²	10	17		Gri	200	2,450 ₺
3076	KSN-İY-0046	K-22060	2 x 6,00 mm ²	12	20		Siyah	100	3,000 ₺
3077	KSN-İY-0047	K-22100	2 x 10,00 mm ²	12	27		Bej	50	4,670 ₺
3078	KSN-İY-0048	K-22160	2 x 16,00 mm ²	12	31		Yeşil	50	6,000 ₺

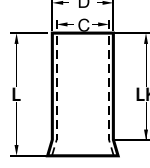

TEKNİK ÖZELLİKLER

Standart: DIN46228

Malzeme: Bakır, kalay kaplı

SİPARİŞ KODU	ÜRÜN KODU	TANIM	KESİT	BOYUTLAR				KUTU ADEDİ	LİSTE FİYATI ₺
				L	LK	C	D		
3091	KSN-İZ-001	K-0,50	0,50 mm ²	10	8	1,0	1,3	2.000	0,530 ₺
3092	KSN-İZ-002	K-0,75	0,75 mm ²	10	8	1,2	1,5	2.000	0,530 ₺
3093	KSN-İZ-003	K-1,00	1,00 mm ²	10	8	1,4	1,7	2.000	0,530 ₺
3094	KSN-İZ-004	K-1,50	1,50 mm ²	10	8	1,7	2,0	2.000	0,590 ₺
3095	KSN-İZ-005A	K-2,50/8	2,50 mm ²	8	8	2,3	2,6	1.000	1,000 ₺
3096	KSN-İZ-005	K-2,50	2,50 mm ²	12	8	2,3	2,6	1.000	0,830 ₺
3097	KSN-İZ-006	K-4,00	4,00 mm ²	12	10	2,8	3,2	1.000	1,120 ₺
3098	KSN-İZ-007	K-6,00	6,00 mm ²	12	10	3,5	3,9	500	1,150 ₺
3099	KSN-İZ-008	K-10,00	10,00 mm ²	12	12	4,5	4,9	200	2,530 ₺
3100	KSN-İZ-009	K-16,00	16,00 mm ²	15	12	5,8	6,2	200	3,100 ₺
3101	KSN-İZ-010	K-25,00	25,00 mm ²	16	16	7,5	7,9	100	4,750 ₺
3102	KSN-İZ-011	K-35,00	35,00 mm ²	16	16	8,3	8,7	100	5,500 ₺
3103	KSN-İZ-012	K-50,00	50,00 mm ²	20	20	10,3	10,9	50	11,500 ₺

YÜKSÜK SETİ

FASTON TİP DİŞİ/ERKEK SET



SİPARİŞ KODU	ÜRÜN KODU	CİNSİ	FİYATI \$ / Ad.
3110	HWA-274C	Yüksük Seti 1200 Parça, 8 Boy, 6 Renk	12,00 \$

SİPARİŞ KODU	ÜRÜN KODU	CİNSİ	FİYATI \$ / Ad.
3111	HWA-274F	İzoleli Faston Dişi/Erkek 200 Parça, 3 Boy, 3 Renk	11,00 \$

KSN® YUVARLAK TİP İZOLELİ KABLO UÇLARI

İTHALATIMIZ

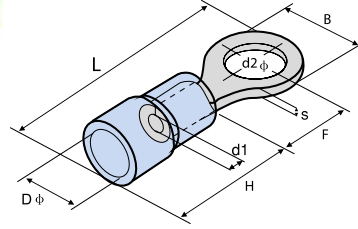

TEKNİK ÖZELLİKLER

Standart: DIN4 6237

Malzeme: Bakır, kalay kaplı

İzolasyon: PVC

Çalışma Sıcaklığı: Maksimum 105 °C, 600 Volt

Naylon kovanın eşsiz huni şekli, iletken kablunun %100 kolay girişini sağlar.

SİPARİŞ KODU	ÜRÜN KODU	RENK	Kablo Kesiti	Civata Ölçüsü	Ölçüler (mm)								Ambalaj Adedi	BİRİM FİYATI ₺
					d2	B	L	F	d1	D	H	s		
3121	KYK-301		0,50 - 1,50 mm ²	M3	3,2	5,7	17,8	4,95	1,6	4,3	10	0,8	200	1,800 ₺
3122	KYK-351			M3,5	3,5	5,7	17,8	4,95					200	2,250 ₺
3123	KYK-401			M4	4,3	8,0	21,5	7,0					200	2,570 ₺
3124	KYK-501			M5	5,3	9,8	23,0	8,5					200	2,880 ₺
3125	KYK-601			M6	6,4	11,6	27,5	11,1					200	4,130 ₺
3126	KYK-801			M8	8,4	11,6	27,5	11,1					200	4,200 ₺
3127	KYK-302		1,50 - 2,50 mm ²	M3	3,2	6,6	17,8	4,3	2,3	4,9	10,0	0,8	200	3,100 ₺
3128	KYK-402			M4	4,3	8,5	22,5	7,75					200	3,200 ₺
3129	KYK-502			M5	5,3	9,5	22,5	7,25					200	3,300 ₺
3130	KYK-602			M6	6,5	12,0	27,6	11,0					200	4,600 ₺
3131	KYK-802			M8	8,4	12,0	27,6	11,0					200	4,700 ₺
3132	KYK-1002			M10	10,5	13,6	30,2	13,9					100	5,200 ₺
3133	KYK-1202			M12	13,0	19,2	25,0	16,5					100	7,500 ₺
3134	KYK-406		4,00 - 6,00 mm ²	M4	4,3	7,2	21,4	5,9	3,6	6,7	13,0	1,0	100	6,650 ₺
3135	KYK-506			M5	5,3	9,5	25,5	8,3					100	6,720 ₺
3136	KYK-606			M6	6,4	12,0	31,5	13,0					100	7,600 ₺
3137	KYK-806			M8	8,4	15,0	33,7	13,7					100	9,840 ₺
3138	KYK-1006			M10	10,5	15,0	33,7	13,7					100	10,000 ₺
3139	KYK-1206			M12	13,0	19,2	38,1	16,0					100	10,300 ₺
3140	KYK-610		6,00 - 10,00 mm ²	M6	6,4	12,0	32,5	9,2	4,5	8,3	17,5	1,2	100	11,300 ₺
3141	KYK-810			M8	8,4	15,0	38,7	13,8					100	14,000 ₺
3142	KYK-1010			M10	10,5	15,0	38,7	13,8					100	16,480 ₺

KSN® ÇATAL TİP İZOLELİ KABLO UÇLARI

İTHALATIMIZ

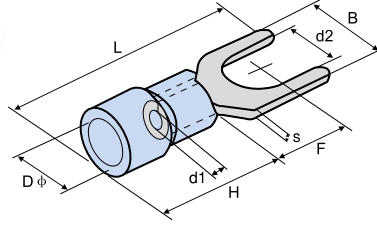

TEKNİK ÖZELLİKLER

Standart: DIN4 6237

Malzeme: Bakır, kalay kaplı

İzolasyon: PVC

Çalışma Sıcaklığı: Maksimum 105 °C, 600 Volt

Naylon kovanın eşsiz huni şekli, iletken kablunun %100 kolay girişini sağlar.

SİPARİŞ KODU	ÜRÜN KODU	RENK	Kablo Kesiti	Civata Ölçüsü	Ölçüler (mm)								Ambalaj Adedi	BİRİM FİYATI ₺
					d2	B	L	F	d1	D	H	s		
3143	KÇK-3001		0,50 ~ 1,50 mm ² 22 ~ 16 AWG	M3	3,2	5,7	21,2	6,5	1,6	4,3	10,0	0,8	200	2,400 ₺
3144	KÇK-4001			M4	4,3	6,4	21,2	6,5					200	2,420 ₺
3145	KÇK-5001			M5	5,3	9,5	21,2	6,5					200	2,880 ₺
3146	KÇK-6001			M6	6,4	12,0	27,2	11,0					200	4,150 ₺
3147	KÇK-3002		1,50 ~ 2,50 mm ² 16 ~ 14 AWG	M3	3,2	5,7	21,2	6,5	2,3	4,9	10,0	0,8	200	2,800 ₺
3148	KÇK-4002			M4	4,3	7,2	21,2	6,5					200	2,870 ₺
3149	KÇK-5002			M5	5,3	9,5	21,2	6,5					200	3,150 ₺
3150	KÇK-6002			M6	6,4	12,0	21,2	11,0					200	4,650 ₺
3151	KÇK-4006		4,00 ~ 6,00 mm ² 12 ~ 10 AWG	M4	4,3	8,3	25,2	7,5	3,6	6,7	13,0	1,0	100	6,100 ₺
3152	KÇK-5006			M5	5,3	9,0	25,2	7,5					100	6,120 ₺
3153	KÇK-6006			M6	6,4	12,0	31,2	12,0					100	8,300 ₺
3154	KÇK-8006			M8	8,4	14,0	30,0	11,5					100	9,500 ₺

KSN® DIŞI FASTON TİP İZOLELİ KABLO UÇLARI

İTHALATIMIZ



EKSTRA
BAKIR
YÜKSÜK

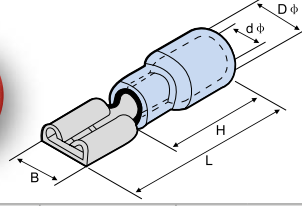

TEKNİK ÖZELLİKLER

Malzeme: Pirinç, kalay kaplı, bakır yüksüklü
İzolasyon: PVC
Çalışma Sıcaklığı: Maksimum 75 °C, 300 Volt

SİPARİŞ KODU	ÜRÜN KODU	RENK	Kablo Kesiti	Soket Genişliği	Ölçüler (mm)					Kutu Adedi	BİRİM FİYATI ₺
					B	D	d	L	H		
3160	KFD-1288/5		0,50 - 1,50 mm ² 22 ~ 16 AWG	0,5 x 2,80	3,8	3,8	1,7	19,0	10,0	200	3,580 ₺
3161	KFD-1288			0,8 x 2,80	3,8	3,8	1,7	19,0	10,0	200	3,580 ₺
3162	KFD-1488/5			0,5 x 4,75	5,6	3,8	1,7	19,0	10,0	200	4,000 ₺
3163	KFD-1488			0,8 x 4,75	5,6	3,8	1,7	19,0	10,0	200	4,000 ₺
3164	KFD-1638			0,8 x 6,35	7,4	3,8	1,7	21,0	10,0	200	4,800 ₺
3165	KFD-2288		1,50 - 2,50 mm ² 16 ~ 14 AWG	0,8 x 2,80	3,8	4,3	2,3	19,0	10,0	200	4,480 ₺
3166	KFD-2488			0,8 x 4,75	5,6	4,3	2,3	19,0	10,0	200	5,000 ₺
3167	KFD-2638			0,8 x 6,35	7,4	4,3	2,3	21,0	10,0	200	5,600 ₺
3168	KFD-5638		4,00 - 6,00 mm ²	0,8 x 6,35	7,4	5,7	3,4	25,0	13,0	100	7,600 ₺
3169	KFD-5956		12 ~ 10 AWG	1,2 x 9,40	10,0	6,2	3,4	28,6	13,0	100	12,750 ₺

KSN® DIŞI FASTON TİP TAM İZOLELİ KABLO UÇLARI

İTHALATIMIZ



EKSTRA
BAKIR
YÜKSÜK

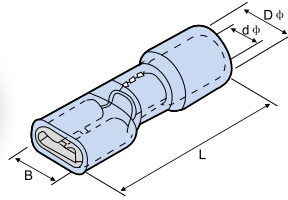

TEKNİK ÖZELLİKLER

Malzeme: Pirinç, kalay kaplı, bakır yüksüklü
İzolasyon: PVC
Çalışma Sıcaklığı: Maksimum 75 °C, 300 Volt

SİPARİŞ KODU	ÜRÜN KODU	RENK	Kablo Kesiti	Soket Genişliği	Ölçüler (mm)				Kutu Adedi	BİRİM FİYATI ₺
					B	D	d	L		
3180	KFFD-1488/5		0,50 ~ 1,50 mm ² 22 ~ 16 AWG	0,5 x 4,75	5,6	3,8	1,7	20,0	200	4,800 ₺
3181	KFFD-1488			0,8 x 4,75	5,6	3,8	1,7	20,0	200	4,800 ₺
3182	KFFD-1638			0,8 x 6,35	7,4	3,8	1,7	21,5	100	5,450 ₺
3183	KFFD-2488		1,50 ~ 2,50 mm ² 16 ~ 14 AWG	0,8 x 4,75	5,6	4,3	2,3	20,0	100	5,600 ₺
3184	KFFD-2638			0,8 x 6,35	7,4	4,3	2,3	21,5	100	6,400 ₺
3185	KFFD-5638		4,00 ~ 6,00 mm ² 12 ~ 10 AWG	0,8 x 6,35	7,4	5,7	3,4	25,5	100	8,320 ₺

KSN® DIŞI FASTON TİP TAM İZOLELİ POLYAMİD KABLO UÇLARI

İTHALATIMIZ



EKSTRA
BAKIR
YÜKSÜK

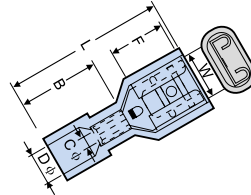

TEKNİK ÖZELLİKLER

Malzeme: Pirinç, kalay kaplı, bakır yüksüklü
İzolasyon: Polyamid
Çalışma Sıcaklığı: Maksimum 105 °C, 300 Volt

SİPARİŞ KODU	ÜRÜN KODU	RENK	Kablo Kesiti	Soket Genişliği	Ölçüler (mm)						Kutu Adedi	BİRİM FİYATI ₺
					W	F	L	B	D	C		
3190	KPFD-1638		0,50 ~ 1,50 mm ² 22 ~ 16 AWG	0,8 x 6,35	6,6	7,3	22,0	11,0	4,0	1,7	100	9,250 ₺
3191	KPFD-2638		1,50 ~ 2,50 mm ² 16 ~ 14 AWG	0,8 x 6,35	6,6	7,3	22,0	11,0	4,5	2,3	100	9,500 ₺
3192	KPFD-5638		4,00 ~ 6,00 mm ² 12 ~ 10 AWG	0,8 x 6,35	6,6	7,3	24,0	13,0	6,3	3,4	100	11,200 ₺

KSN® ERKEK FASTON TİP İZOLELİ KABLO UÇLARI

İTHALATIMIZ



EKSTRA
BAKIR
YÜKSÜK

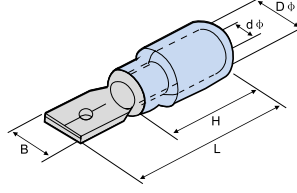

TEKNİK ÖZELLİKLER

Malzeme: Pirinç, kalay kaplı, bakır yüksüklü
İzolasyon: PVC
Çalışma Sıcaklığı: Maksimum 75 °C, 300 Volt

SİPARİŞ KODU	ÜRÜN KODU	RENK	Kablo Kesiti	Soket Genişliği	Ölçüler (mm)					Kutu Adedi	BİRİM FİYATI ₺
					B	d	D	L	H		
3200	KFE-1288		0,50 ~ 1,50 mm ² 22 ~ 16 AWG	0,8 x 2,80	2,8	1,7	4,3	17,7	10,0	200	4,000 ₺
3201	KFE-1488			0,8 x 4,75	4,75	1,7	4,3	20,0	10,0	200	4,480 ₺
3202	KFE-1638			0,8 x 6,35	6,35	1,7	4,3	21,0	10,0	200	4,680 ₺
3203	KFE-2488		1,50 ~ 2,50 mm ² 16 ~ 14 AWG	0,8 x 4,75	4,75	2,3	4,3	20,0	10,0	200	5,230 ₺
3204	KFE-2638			0,8 x 6,35	6,35	2,3	4,3	21,0	10,0	200	5,230 ₺
3205	KFE-5638		4,00 ~ 6,00 mm ² 12 ~ 10 AWG	0,8 x 6,35	6,35	3,4	5,7	25,0	13,0	100	7,120 ₺

KSN® ERKEK/DİŞİ GERİ DÖNÜŞLÜ İZOLELİ KABLO UÇLARI

İTHALATIMIZ



EKSTRA
BAKIR
YÜKSÜK

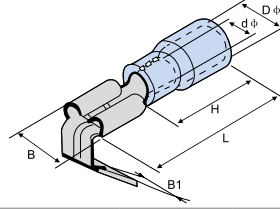

TEKNİK ÖZELLİKLER

Malzeme: Pirinç, kalay kaplı, bakır yüksüklü
İzolasyon: PVC
Çalışma Sıcaklığı: Maksimum 75 °C, 300 Volt

SİPARİŞ KODU	ÜRÜN KODU	RENK	Kablo Kesiti	Soket Genişliği	Ölçüler (mm)						Kutu Adedi	BİRİM FİYATI ₺
					B	B1	L	H	D	d		
3210	KFDEG-1861		1,50 ~ 2,50 mm ² 22 ~ 16 AWG	0,8 x 6,35	7,4	6,35	21,5	10,0	3,8	1,7	100	7,520 ₺
3211	KFDEG-2862		1,50 ~ 2,50 mm ² 16 ~ 14 AWG	0,8 x 6,35	7,4	6,35	21,5	10,0	4,3	2,3	100	8,400 ₺
3212	KFDEG-5866		4,00 ~ 6,00 mm ² 12 ~ 10 AWG	0,8 x 6,35	7,4	6,35	25,0	13,0	5,7	3,4	100	9,000 ₺

KSN® BAYRAK TİP TAM İZOLELİ POLYAMİD KABLO UÇLARI

İTHALATIMIZ



EKSTRA
BAKIR
YÜKSÜK

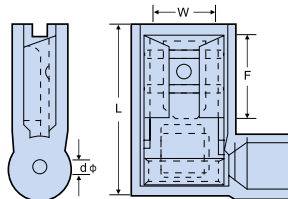

TEKNİK ÖZELLİKLER

Malzeme: Pirinç, kalay kaplı, bakır yüksüklü
İzolasyon: PVC
Çalışma Sıcaklığı: Maksimum 75 °C, 300 Volt

SİPARİŞ KODU	ÜRÜN KODU	Kablo Kesiti	Soket Genişliği	Ölçüler (mm)				Kutu Adedi	BİRİM FİYATI ₺
				W	F	L	d		
3215	KPFDEB-1861	0,50 - 1,50 mm ² 22 ~ 16 AWG	0,8 x 6,35	6,6	7,6	16	1,7	100	6,800 ₺
3216	KPFDEB-2862	1,50 - 2,50 mm ² 16 ~ 14 AWG	0,8 x 6,35	6,6	7,6	16	2,3	100	7,000 ₺

KSN® İZOLELİ ERKEK TERMİNALLER

İTHALATIMIZ



EKSTRA
BAKIR
YÜKSÜK

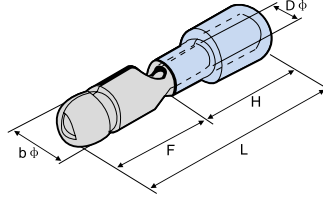

TEKNİK ÖZELLİKLER

Malzeme: Pirinç, kalay kaplı, bakır yüksüklü
İzolasyon: PVC
Çalışma Sıcaklığı: Maksimum 75 °C, 300 Volt

SİPARİŞ KODU	ÜRÜN KODU	Kablo Kesiti	Ölçüler (mm)					Kutu Adedi	BİRİM FİYATI ₺
			b	F	L	H	D		
3230	KBE-1040	0,50 ~ 1,50 mm ² 22 ~ 16 AWG	4,0	11,0	21,0	10,0	1,7	200	6,000 ₺
3231	KBE-2040	1,50 ~ 2,50 mm ² 16 ~ 14 AWG	4,0	11,0	21,0	10,0	2,3	200	6,200 ₺
3232	KBE-2050		5,0	11,0	21,0	10,0	2,3	200	7,000 ₺
3233	KBE-5050	4,00 ~ 6,00 mm ² 12 ~ 10 AWG	5,0	12,0	25,0	13,0	3,4	100	9,100 ₺

KSN® İZOLELİ DIŞI TERMİNALLER

İTHALATIMIZ



EKSTRA
BAKIR
YÜKSÜK

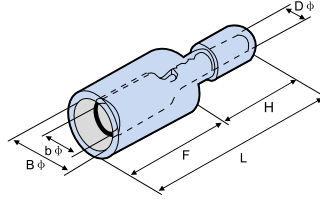

TEKNİK ÖZELLİKLER

Malzeme: Pirinç, kalay kaplı, bakır yüksüklü
İzolasyon: PVC
Çalışma Sıcaklığı: Maksimum 75 °C, 300 Volt

SİPARİŞ KODU	ÜRÜN KODU	Kablo Kesiti	Ölçüler (mm)					Kutu Adedi	BİRİM FİYATI ₺
			b	F	L	H	D		
3240	KBD-1040	0,50 ~ 1,50 mm ² 22 ~ 16 AWG	4,0	6,3	24,5	13,0	1,7	100	7,100 ₺
3241	KBD-2040	1,50 ~ 2,50 mm ² 16 ~ 14 AWG	4,0	6,3	24,5	14,0	2,3	100	7,200 ₺
3242	KBD-2050		5,0	7,0	25,5	14,0	2,3	100	8,100 ₺
3243	KBD-5050	4,00 ~ 6,00 mm ² 12 ~ 10 AWG	5,0	7,0	29,5	14,0	3,4	100	10,000 ₺

KSN® İZOLELİ KABLO UCU EK MUFLARI

İTHALATIMIZ

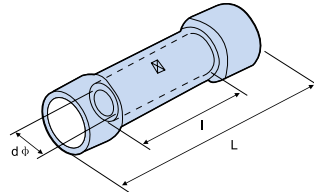

TEKNİK ÖZELLİKLER

Malzeme: Bakır, kalay kaplı
İzolasyon: PVC
Çalışma Sıcaklığı: Maksimum 105 °C, 600 Volt

SİPARİŞ KODU	ÜRÜN KODU	Kablo Kesiti	Ölçüler (mm)			Kutu Adedi	BİRİM FİYATI ₺
			L	d	l		
3250	KBY-251	0,50 ~ 1,50 mm ² 22 ~ 16 AWG	26,0	1,7	15,0	200	3,700 ₺
3251	KBY-252	1,50 ~ 2,50 mm ² 16 ~ 14 AWG	26,0	2,3	15,0	200	4,900 ₺
3252	KBY-256	4,00 ~ 6,00 mm ² 12 ~ 10 AWG	26,0	3,4	15,0	100	9,300 ₺

KSN® İĞNE TİP İZOLELİ KABLO UÇLARI

İTHALATIMIZ

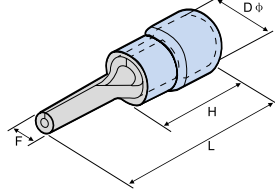

TEKNİK ÖZELLİKLER

Malzeme: Bakır, kalay kaplı

İzolasyon: PVC

Çalışma Sıcaklığı: Maksimum 105 °C, 600 Volt

SİPARİŞ KODU	ÜRÜN KODU	RENK	Kablo Kesiti	Ölçüler (mm)						Kutu Adedi	BİRİM FİYATI ₺
				F	L	H	D	d1	Kalınlık		
3260	KİK-101		0,50 ~ 1,50 mm ² 22 ~ 16 AWG	1,9	19	10,0	4,3	1,7	0,75	200	2,800 ₺
3261	KİK-102		1,50 ~ 2,50 mm ² 16 ~ 14 AWG	1,9	22,0	10,0	4,9	2,3	0,80	200	3,400 ₺
3262	KİK-106		4,00 ~ 6,00 mm ² 12 ~ 10 AWG	2,8	25,5	13,0	6,7	3,4	1,00	100	8,000 ₺

KSN® BIÇAK TİP İZOLELİ KABLO UÇLARI

İTHALATIMIZ

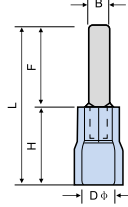

TEKNİK ÖZELLİKLER

Malzeme: Bakır, kalay kaplı

İzolasyon: PVC

Çalışma Sıcaklığı: Maksimum 105 °C, 600 Volt

SİPARİŞ KODU	ÜRÜN KODU	Kablo Kesiti	Ölçüler (mm)					Kutu Adedi	BİRİM FİYATI ₺	
			B	L	F	H	D			
3263	KİK-101/14		0,50 - 1,50 mm ² 22 ~ 16 AWG	2,3	24	14	10	4,3	100	3,000 ₺
3264	KİK-102/18		1,50 - 2,50 mm ² 16 ~ 14 AWG	2,3	28	18	10	4,9	100	4,300 ₺

KSN® UCU KIVRIK BIÇAK TİP İZOLELİ KABLO UÇLARI

İTHALATIMIZ

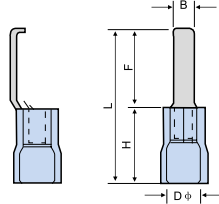

TEKNİK ÖZELLİKLER

Malzeme: Bakır, kalay kaplı

İzolasyon: PVC

Çalışma Sıcaklığı: Maksimum 105 °C, 600 Volt

SİPARİŞ KODU	ÜRÜN KODU	RENK	Kablo Kesiti	Ölçüler (mm)					Kutu Adedi	BİRİM FİYATI ₺
				B	L	F	H	D		
3270	KLBV-1.25-3		0,50 ~ 1,50 mm ² 22 ~ 16 AWG	3,0	26,8	16,8	10,0	4,3	200	4,560 ₺
3271	KLBV-1.25-4.6			4,6	26,8	16,8	10,0	4,3	200	5,440 ₺
3272	KLBV-2-3		1,50 ~ 2,50 mm ² 16 ~ 14 AWG	3,0	26,8	16,8	10,0	4,9	100	4,200 ₺
3273	KLBV-2-4.6			4,6	26,8	16,8	10,0	4,9	100	7,000 ₺
3274	KLBV-5.5-4.6		4,00 ~ 6,00 mm ² 12 ~ 10 AWG	4,6	29,3	16,8	13,0	6,7	100	9,750 ₺

KSN® ISI BÜZÜŞMELİ EK MUF

İTHALATIMIZ

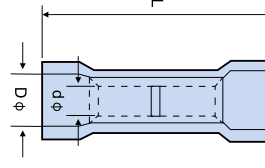

TEKNİK ÖZELLİKLER

Malzeme: Bakır, kalay kaplı

İzolasyon: Isı ile daralan makaron





Çalışma Sıcaklığı: Maksimum 105 °C, 600 Volt

SİPARİŞ KODU	ÜRÜN KODU	RENK	Kablo Kesiti	Ölçüler (mm)			Poşet Adedi	BİRİM FİYATI ₺
				L	d	D		
3280	KBHT-1		0.5 ~ 1.5 mm ² 22 ~ 16 AWG	26.0	1.8	4.2	100	12,800 ₺
3281	KBHT-2		1.5 ~ 2.5 mm ² 16 ~ 14 AWG	26.0	2.4	4.8	100	15,200 ₺
3282	KBHT-3		4.0 ~ 6.0 mm ² 12 ~ 10 AWG	27.0	3.6	4.8	100	20,000 ₺

KSN® ISI BÜZÜŞMELİ EK MUF (LEHİMLİ)

İTHALATIMIZ



SİPARİŞ KODU	ÜRÜN KODU	RENK	Kablo Kesiti	Poşet Adedi	BİRİM FİYATI \$
3283	BHTS-0.5	 Beyaz	0,25 - 0,34 mm ²	100	0,080 \$
3284	BHTS-1	 Kırmızı	0,50 - 1,50 mm ²	100	0,100 \$
3285	BHTS-2	 Mavi	1,50 - 2,50 mm ²	100	0,120 \$
3286	BHTS-5	 Sarı	4,00 - 6,00 mm ²	100	0,145 \$

AYDINLATMA İÇİN KABLO SOKETLER

IP 67 DIŞ MEKAN BAĞLANTI ELEMANI

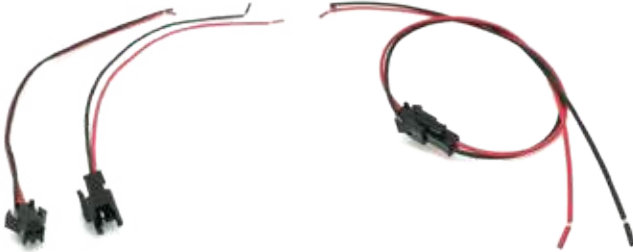

SİPARİŞ KODU	cinsi	FİYATI \$ / TK.
3291	KON-305 15cm KABLULU SOKET	0,16 \$/NET
3292	KON-305A 20CM KABLULU SOKET	0,18 \$/NET

SİPARİŞ KODU	cinsi	FİYATI \$ / Ad.
3293	KON-282 IP67 DIŞ MEKAN BAĞLANTI KLEMENSİ	1,85 \$ / NET

KSN® VIDALI BUAT KLEMENSLERİ

İTHALATIMIZ

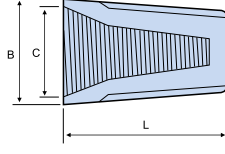
**TEKNİK ÖZELLİKLER****Malzeme:** Piriç, kalay kaplı**İzolasyon:** PVC**Çalışma Sıcaklığı:** Maksimum 105 °C, 600 Volt

SİPARİŞ KODU	ÜRÜN KODU	RENK	Ölçüler (mm)			Poşet Adedi	BİRİM FİYATI ₺
			B	C	L		
3300	KP-1		8,5	6,7	15,0	100	1,150 ₺
3301	KP-2		10,1	7,4	17,5	100	1,360 ₺
3302	KP-3		12,6	9,9	22,1	100	2,300 ₺
3303	KP-4		13,7	11,0	24,5	100	3,000 ₺
3304	KP-6		16,0	13,0	26,5	100	4,650 ₺

KSN® HIZLI KABLO EKLEME PARÇASI

İTHALATIMIZ

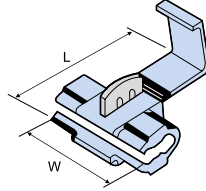
**TEKNİK ÖZELLİKLER****Malzeme:** Piriç, kalay kaplı**İzolasyon:** Naylon**Çalışma Sıcaklığı:** Maksimum 105 °C, 600 Volt

SİPARİŞ KODU	ÜRÜN KODU	RENK	Kablo Kesiti	Ölçüler (mm)		Poşet Adedi	BİRİM FİYATI ₺
				W	L		
3305	KSP-1		0.5 ~ 1.0	20,0	27,0	1000	4,000 ₺
3306	KSP-2		1.0 ~ 2.5	20,0	27,0	1000	4,000 ₺
3307	KSP-5		4.0 ~ 6.0	20,5	34,5	500	6,500 ₺

İKİ TARAF BASMALI KLEMENSLER

SİPARİŞ KODU	KOD	CİNSİ	BİRİM FİYATI ₺
3310	KON-296	No.1 İkili Vidasız Klemens	3,50 ₺
3311	KON-297	No.1 Üçlü Vidasız Klemens	5,00 ₺

İKİ TARAFLI MANDALLI KLEMENSLER

SİPARİŞ KODU	ÜRÜN KODU	CİNSİ	Kablo Kesiti	Kutu Adedi	BİRİM FİYATI ₺
3312	KCT-1	1-1'Li	0,2-4 mm ²	50	19,30 ₺
3313	KCT-2	1-2'Li	0,2-4 mm ²	50	34,00 ₺
3314	KCT-3	1-3'Li	0,2-4 mm ²	50	44,30 ₺
3342	KCT-4	1-4'LÜ	0,2-4 mm ²	50	45,00 ₺
3343	KCT-5	1-5'Li	0,2-4 mm ²	50	55,00 ₺

KOMPAKT ÇOK AMAÇLI KLEMENSLER

Gövde malzeme: Polikarbon
Kablo kesiti: 0,2-4,00 mm²/ 24-12 AWG
Kablo soyma uzunluğu: 11 mm
Sürekli çalışma sıcaklığı: Max. 105 °C
Ortam sıcaklığı: Max. 85 °C
Nominal akım: 32 A
Nominal gerilim: 450 V
Not: Tırnakları kaldırmadan,
kablونuzu ileriye iterek kolay montaj imkanı.

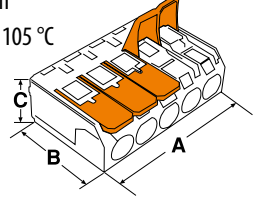

SİPARİŞ KODU	ÜRÜN KODU	AÇIKLAMA	Kablo Kesiti	K. ADET	ADET (₺)
3319	KPCG-622	2 İletken Bağlantılı	0,2 - 4 mm ²	100	14,00 ₺
3320	KPCG-623	3 İletken Bağlantılı	0,2 - 4 mm ²	100	17,00 ₺
3321	KPCG-624	4 İletken Bağlantılı	0,2 - 4 mm ²	100	20,00 ₺
3322	KPCG-625	5 İletken Bağlantılı	0,2 - 4 mm ²	100	25,00 ₺

İNCE MANDALLI AÇILABİLİR BUAT KLEMENSLERİ

SİPARİŞ KODU	ÜRÜN KODU	Kutup Sayısı	Kablo Kesiti	Ölçüler (mm)			Poşet Adedi	Adet Fiyatı (₺)
				A	B	H		
3332	KPCI-622	2	0.2-4 mm ²	12.2	20.7	14.5	500	16,50 ₺
3333	KPCI-623	3	0.2-4 mm ²	16.8	20.7	14.5	500	18,20 ₺
3334	KPCI-625	5	0.2-4 mm ²	26.0	20.7	14.5	300	31,00 ₺

**TEK DAMAR İLETKENLER İÇİN BUAT KLEMENSLER**

SİPARİŞ KODU	ÜRÜN KODU	RENK	KUTUP SAYISI	KABLO KESİTİ	Kutu Adedi	Adet Fiyatı (₺)
3336	KSDK - 2	○ Beyaz	2	2,5 mm ²	100	6,30 ₺
3337	KSDK - 3	● Turuncu	3	2,5 mm ²	100	7,20 ₺
3338	KSDK - 4	● Kırmızı	4	2,5 mm ²	100	8,00 ₺
3339	KSDK - 5	● Sarı	5	2,5 mm ²	100	9,00 ₺
3340	KSDK - 6	● Mavi	6	2,5 mm ²	250	12,00 ₺
3341	KSDK - 8	● Gri	8	2,5 mm ²	200	13,00 ₺

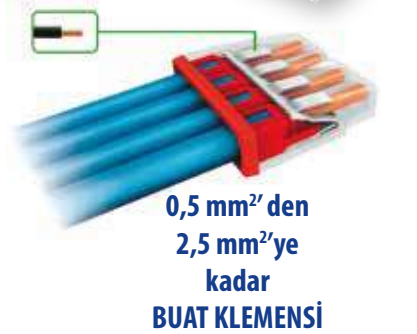
**221 SERİSİ KOMPAKT ÇOK AMAÇLI KLEMENS**

Tüm Kablo Çeşitleri İçin

SİPARİŞ KODU	ÜRÜN KODU	AÇIKLAMA	Kutu Adedi	Adet Fiyatı (₺)
3351	KSN-412	2 İletken Bağlantılı / 2x4 mm ²	100	0,59 €
3352	KSN-413	3 İletken Bağlantılı / 3x4 mm ²	50	0,73 €
3353	KSN-415	5 İletken Bağlantılı / 5x4 mm ²	25	1,17 €

WAGO

- Nominal akım: 32 A
- Sürekli çalışma sıcaklığı: Maks. 105 °C
- Nominal gerilim: 450 V
- Ortam sıcaklığı: aks. 85 °C (T85)
- Yüksek sıcaklıklar için
- 0,14-4 mm² (24-12 AWG)
- 0,2-4 mm² (24-12 AWG)



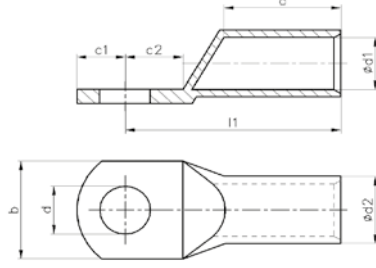

TEKNİK ÖZELLİKLER

Malzeme: EN 13600 Bakır
Kaplama: Kalay kaplı

SİPARİŞ KODU	ÜRÜN KODU	Kablo Kesiti mm ²	Civata Deliği	Boyutlar (mm)								Kutu Miktarı (Adet)	BİRİM FİYATI ₺
				d	d1	d2	l1	a	b	c1	c2		
3401	KSNSKPS-01005	10 mm ²	M5	5,5	4,5	6,5	22,0	11,5	10,0	7,0	7,0	800	20,500 ₺
3402	KSNSKPS-01006		M6	6,5	1,5	6,5	22,0	11,5	11,0	7,0	7,0	800	20,500 ₺
3403	KSNSKPS-01008		M8	8,5	4,5	6,5	23,0	11,5	13,5	8,0	8,0	800	20,500 ₺
3405	KSNSKPS-01606	16 mm ²	M6	6,5	5,5	7,5	24,0	12,5	12,0	7,5	7,5	500	28,000 ₺
3406	KSNSKPS-01608		M8	8,5	5,5	7,5	25,5	13,0	13,5	8,0	8,0	500	30,000 ₺
3407	KSNSKPS-01610		M10	10,5	5,5	7,5	25,5	13,0	13,5	9,0	9,0	500	30,000 ₺
3408	KSNSKPS-02506	25 mm ²	M6	6,5	7,0	9,5	30,5	17,0	14,0	8,5	8,5	300	48,000 ₺
3409	KSNSKPS-02508		M8	8,5	7,0	9,5	30,5	17,0	14,0	8,5	8,5	300	48,000 ₺
3410	KSNSKPS-02510		M10	10,5	7,0	9,5	31,5	17,0	16,0	10,0	10,0	300	52,000 ₺
3412	KSNSKPS-03506	35 mm ²	M6	6,5	8,5	11,0	24,5	19,0	16,0	9,5	9,5	200	69,000 ₺
3413	KSNSKPS-03508		M8	8,5	8,5	11,0	34,5	19,0	16,5	9,5	9,5	200	69,000 ₺
3414	KSNSKPS-03510		M10	10,5	8,5	11,0	35,0	19,0	16,5	10,0	10,0	200	73,000 ₺
3415	KSNSKPS-03512		M12	13,0	8,5	11,0	37,0	19,0	18,0	11,0	11,0	200	73,000 ₺
3416	KSNSKPS-05006	50 mm ²	M6	6,5	10,0	13,0	40,0	21,0	19,0	11,0	11,0	150	100,000 ₺
3417	KSNSKPS-05008		M8	8,5	10,0	13,0	40,0	21,0	19,0	11,0	11,0	150	100,000 ₺
3418	KSNSKPS-05010		M10	10,5	10,0	13,0	40,0	21,0	19,0	11,0	11,0	150	105,000 ₺
3419	KSNSKPS-05012		M12	13,0	10,0	13,0	40,0	21,0	19,0	11,0	11,0	150	105,000 ₺
3421	KSNSKPS-07008	70 mm ²	M8	8,5	11,5	14,5	41,5	23,0	21,5	11,0	11,0	100	143,000 ₺
3422	KSNSKPS-07010		M10	10,5	11,5	14,5	41,5	23,0	21,5	11,0	11,0	100	143,000 ₺
3423	KSNSKPS-07012		M12	13,0	11,5	14,5	41,5	23,0	21,5	11,0	11,0	100	143,000 ₺
3424	KSNSKPS-07014		M14	15,0	11,5	14,5	43,5	23,0	23,0	13,0	13,0	100	160,000 ₺
3425	KSNSKPS-07016		M16	17,0	11,5	14,5	46,5	23,0	23,0	16,0	16,0	100	160,000 ₺

* Ürünlerimiz elektrolitik bakırdan (E-Cu), ekstra cam tavli, çapaksız havşalı ve minimum 3 mikron kalay kaplıdır.

* Firmamız önceden haber vermeden ürün ölçülerinde değişiklik yapma hakkını saklı tutar.

KSN® STANDART TİP SIKMALI KABLO PABUÇLARI

İMALATIMIZ

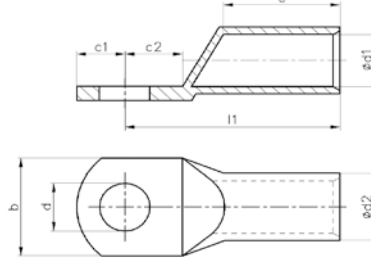

TEKNİK ÖZELLİKLER

Malzeme: EN 13600 Bakır
Kaplama: Kalay kaplı

SİPARİŞ KODU	ÜRÜN KODU	Kablo Kesiti mm ²	Civata Deliği	Boyutlar (mm)								Kutu Miktarı (Adet)	BİRİM FİYATI ₺
				d	d1	d2	l1	a	b	c1	c2		
3426	KSNSKPS-09508	95 mm ²	M8	8,5	13,5	16,5	48,0	26,0	24,0	12,0	12,5	80	175,000 ₺
3427	KSNSKPS-09510		M10	10,5	13,5	16,5	48,0	26,0	24,0	12,0	12,5	80	175,000 ₺
3428	KSNSKPS-09512		M12	13,0	13,5	16,5	48,0	26,0	24,0	12,0	12,5	80	175,000 ₺
3429	KSNSKPS-09514		M14	15,0	11,5	14,5	50,0	26,0	26,0	14,0	14,0	80	202,000 ₺
3430	KSNSKPS-09516		M16	17,0	11,5	14,5	52,0	26,0	26,0	16,0	16,0	80	202,000 ₺
3431	KSNSKPS-12010	120 mm ²	M10	10,5	14,5	18,0	52,0	27,0	26,0	14,0	14,0	50	242,000 ₺
3432	KSNSKPS-12012		M12	13,0	14,5	18,0	52,0	27,0	26,5	14,0	14,0	50	242,000 ₺
3433	KSNSKPS-12014		M14	15,0	14,5	18,0	52,0	27,0	26,0	14,0	14,0	50	242,000 ₺
3434	KSNSKPS-12016		M16	17,0	14,5	18,0	52,0	27,0	26,0	14,0	14,0	50	242,000 ₺
3435	KSNSKPS-15010	150 mm ²	M10	10,5	16,5	21,0	57,0	30,0	30,5	15,0	15,0	30	390,000 ₺
3436	KSNSKPS-15012		M12	13,0	16,5	21,0	57,0	30,0	30,5	15,0	15,0	30	390,000 ₺
3437	KSNSKPS-15014		M14	15,0	16,5	21,0	57,0	30,0	30,5	15,0	15,0	30	390,000 ₺
3438	KSNSKPS-15016		M16	17,0	16,5	21,0	57,0	30,0	30,5	15,0	15,0	30	390,000 ₺
3439	KSNSKPS-18510	185 mm ²	M10	10,5	18,5	23,0	65,5	33,5	34,0	17,0	18,0	30	480,000 ₺
3440	KSNSKPS-18512		M12	13,0	18,5	23,0	65,5	33,5	34,0	17,0	18,0	30	480,000 ₺
3441	KSNSKPS-18514		M14	15,0	18,5	23,0	65,5	33,5	34,0	17,0	18,0	30	480,000 ₺
3442	KSNSKPS-18516		M16	17,0	18,5	23,0	65,5	33,5	34,0	17,0	18,0	30	480,000 ₺
3443	KSNSKPS-24010	240 mm ²	M10	10,5	21,0	26,0	72,0	39,0	38,0	17,0	18,0	25	630,000 ₺
3444	KSNSKPS-24012		M12	13,0	21,0	26,0	72,0	39,0	38,0	17,0	18,0	25	630,000 ₺
3445	KSNSKPS-24014		M14	15,0	21,0	26,0	72,0	39,0	38,0	17,0	18,0	25	630,000 ₺
3446	KSNSKPS-24016		M16	17,0	21,0	26,0	72,0	39,0	38,0	17,0	18,0	25	630,000 ₺
3447	KSNSKPS-30012	300 mm ²	M12	13,0	23,5	28,5	77,0	41,0	42,0	19,0	19,0	20	750,000 ₺
3448	KSNSKPS-30014		M14	15,0	23,5	28,5	77,0	41,0	42,0	19,0	19,0	20	750,000 ₺
3449	KSNSKPS-30016		M16	17,0	23,5	28,5	77,0	41,0	42,0	19,0	19,0	20	750,000 ₺

* Ürünlerimiz elektrolitik bakırdan (E-Cu), ekstra cam tavlı, çapaksız havşalı ve minimum 3 mikron kalay kaplıdır.

* Firmamız önceden haber vermeden ürün ölçülerinde değişiklik yapma hakkını saklı tutar.

KSN® EKO TİP SIKMALI KABLO PABUÇLARI

İMALATIMIZ

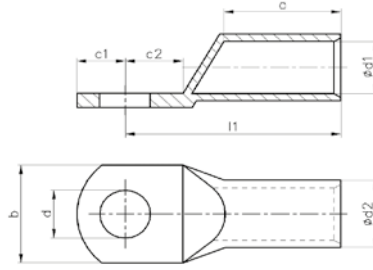

TEKNİK ÖZELLİKLER

Malzeme: EN 13600 Bakır
Kaplama: Kalay kaplı

SİPARİŞ KODU	ÜRÜN KODU	Kablo Kesiti mm ²	Civata Deliği	Boyutlar (mm)								Kutu Miktarı (Adet)	BİRİM FİYATI ₺
				d	d1	d2	l1	a	b	c1	c2		
3461	KSNSKPE-01606	10 mm ²	M5	5,5	4,5	6,0	22,0	11,5	9,0	7,0	7,0	800	19,800 ₺
3462	KSNSKPE-01606	16 mm ²	M6	6,5	5,5	7,0	24,0	12,5	10,5	7,5	7,5	500	20,000 ₺
3463	KSNSKPE-02508	25 mm ²	M8	8,5	7,0	9,0	30,5	17,5	14,0	8,5	8,5	300	35,000 ₺
3464	KSNSKPE-03508	35 mm ²	M8	8,5	8,5	10,5	34,0	18,5	16,0	9,5	9,5	200	45,000 ₺
3465	KSNSKPE-05010	50 mm ²	M10	10,5	10,0	12,0	39,5	20,0	18,0	11,0	11,0	150	58,000 ₺
3466	KSNSKPE-07010	70 mm ²	M10	10,5	11,5	14,0	42,0	22,0	21,1	11,0	11,0	100	90,000 ₺
3467	KSNSKPE-09510	95 mm ²	M12	10,5	13,5	16,0	48,0	25,0	24,5	12,0	12,5	80	112,000 ₺
3468	KSNSKPE-12012	120 mm ²	M12	13,0	15,5	18,0	52,0	27,0	27,0	14,0	14,0	50	152,000 ₺
3469	KSNSKPE-15012	150 mm ²	M12	13,0	16,5	20,0	54,5	29,0	29,0	14,0	14,0	30	270,000 ₺
3470	KSNSKPE-18516	185 mm ²	M16	17,0	18,5	22,0	61,5	32,0	32,0	14,5	14,5	30	310,000 ₺
3471	KSNSKPE-24016	240 mm ²	M16	17,0	21,5	25,0	69,0	36,5	37,5	16,0	16,0	25	425,000 ₺

KSN® EKO TİP EK MUFLAR

İMALATIMIZ

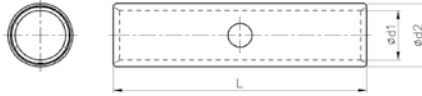

TEKNİK ÖZELLİKLER

Malzeme: EN 13600 Bakır
Kaplama: Kalay kaplı

SİPARİŞ KODU	ÜRÜN KODU	Kablo Kesiti mm ²	Boyutlar (mm)			Kutu Miktarı (Adet)	BİRİM FİYATI ₺
			d1	d2	L		
3481	KSNEKMUF-010	10 mm ²	4,5	6,0	29,0	400	21,000 ₺
3482	KSNEKMUF-016	16 mm ²	5,5	7,0	32,0	400	22,000 ₺
3483	KSNEKMUF-025	25 mm ²	7,0	9,0	40,0	250	38,000 ₺
3484	KSNEKMUF-035	35 mm ²	8,5	10,5	45,0	150	50,000 ₺
3485	KSNEKMUF-050	50 mm ²	10,0	12,0	50,0	90	55,000 ₺
3486	KSNEKMUF-070	70 mm ²	11,5	14,0	55,0	65	80,000 ₺
3487	KSNEKMUF-095	95 mm ²	13,5	16,0	60,0	50	105,000 ₺
3488	KSNEKMUF-120	120 mm ²	15,5	18,0	65,0	40	130,000 ₺
3489	KSNEKMUF-150	150 mm ²	16,5	20,0	70,0	25	230,000 ₺
3490	KSNEKMUF-185	185 mm ²	18,5	22,0	75,0	22	280,000 ₺
3491	KSNEKMUF-240	240 mm ²	21,5	25,5	85,0	18	385,000 ₺

* Ürünlerimiz elektrolitik bakırdan (E-Cu), ekstra cam tavli, çapaksız havşalı ve minimum 3 mikron kalay kaplıdır.

* Firmamız önceden haber vermeden ürün ölçülerinde değişiklik yapma hakkını saklı tutar.

KSN® DIN 46234 TİP YUVARLAK (KAYNAKLI) KABLO PABUÇLARI

İTHALATIMIZ



Özellikler

- DIN 46234 e göre üretilmiştir
- Sıkma alanında sert lehimli
- Gelişmiş sıkma özellikleri için oluklu profil

Malzeme : Cu-ETP
Yüzey : Kalay kaplı

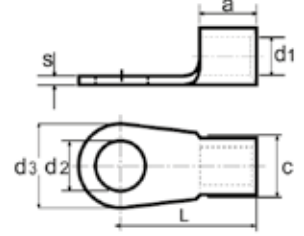

SİPARİŞ KODU	ÜRÜN KODU	Kablo Kesiti mm ²	Civata Ø	Boyutlar (mm)						Kutu Miktarı (Adet)	BİRİM FİYATI \$
				d3	L	a	c	d1	S		
3501	KSNKYN-3-1	1,5	M3	8,0	12,0	5,0	4,0	1,6	0,8	1.000	0,106 \$
3502	KSNKYN-4-1		M4	8,0	12,0	5,0	4,0	1,6	0,8	1.000	0,106 \$
3503	KSNKYN-5-1		M5	10,0	13,0	5,0	4,0	1,6	0,8	1.000	0,119 \$
3504	KSNKYN-6-1		M6	10,0	13,0	5,0	4,0	1,6	0,8	1.000	0,133 \$
3505	KSNKYN-4-2,5	2,5	M4	8,0	12,0	5,0	4,5	2,3	0,8	1.000	0,106 \$
3506	KSNKYN-5-2,5		M5	10,0	14,0	5,0	4,5	2,3	0,8	1.000	0,133 \$
3507	KSNKYN-6-2,5		M6	11,0	16,0	5,0	4,5	2,3	0,8	1.000	0,159 \$
3508	KSNKYN-8-2,5		M8	14,00	17,00	5,0	4,5	2,3	0,8	1.000	0,186 \$
3509	KSNKYN-4-6	6	M4	8,0	14,0	6,0	6,0	3,6	1,0	1.000	0,212 \$
3510	KSNKYN-5-6		M5	10,0	15,0	6,0	6,0	3,6	1,0	1.000	0,220 \$
3511	KSNKYN-6-6		M6	11,0	16,0	6,0	6,0	3,6	1,0	1.000	0,212 \$
3512	KSNKYN-8-6		M8	14,0	19,0	6,0	6,0	3,6	1,0	1.000	0,279 \$
3513	KSNKYN-10-6		M10	18,0	21,0	6,0	6,0	3,6	1,0	500	0,332 \$
3514	KSNKYN-5-10	10	M5	10,0	16,0	8,0	8,0	4,5	1,1	500	0,332 \$
3515	KSNKYN-6-10		M6	11,0	17,0	8,0	8,0	4,5	1,1	500	0,345 \$
3516	KSNKYN-8-10		M8	14,0	20,0	8,0	8,0	4,5	1,1	500	0,399 \$
3517	KSNKYN-10-10		M10	18,0	21,0	8,0	8,0	4,5	1,1	500	0,465 \$
3518	KSNKYN-5-16	16	M5	11,0	20,0	10,0	10,5	5,8	1,2	500	0,518 \$
3519	KSNKYN-6-16		M6	11,0	20,0	10,0	10,5	5,8	1,2	500	0,532 \$
3520	KSNKYN-8-16		M8	14,0	22,0	10,0	10,5	5,8	1,2	500	0,558 \$
3521	KSNKYN-10-16		M10	18,0	24,0	10,0	10,5	5,8	1,2	500	0,638 \$
3522	KSNKYN-12-16		M12	18,0	24,0	10,0	10,5	5,8	1,2	500	0,678 \$
3523	KSNKYN-5-25	25	M5	12,0	25,0	11,0	12,0	7,5	1,5	250	0,798 \$
3524	KSNKYN-6-25		M6	12,0	25,0	11,0	12,0	7,5	1,5	250	0,798 \$
3525	KSNKYN-8-25		M8	16,0	25,0	11,0	12,0	7,5	1,5	200	0,798 \$
3526	KSNKYN-10-25		M10	18,0	26,0	11,0	12,0	7,5	1,5	200	0,957 \$
3527	KSNKYN-12-25		M12	18,0	26,0	11,0	12,0	7,5	1,5	200	0,957 \$
3528	KSNKYN-6-35	35	M6	15,0	26,0	12,0	15,0	9,0	1,6	200	1,130 \$
3529	KSNKYN-8-35		M8	16,0	26,0	12,0	15,0	9,0	1,6	200	1,276 \$
3530	KSNKYN-10-35		M10	18,0	27,0	12,0	15,0	9,0	1,6	100	1,276 \$
3531	KSNKYN-12-35		M12	18,0	27,0	12,0	15,0	9,0	1,6	100	1,276 \$



Özellikler

- DIN 46234 e göre üretilmiştir
- Sıkma alanında sert lehimli
- Gelişmiş sıkma özellikleri için oluklu profil

Malzeme : Cu-ETP
Yüzey : Kalay kaplı

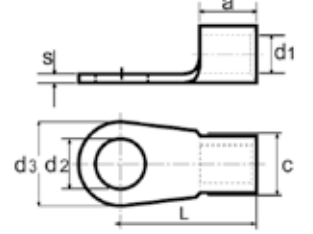

SİPARİŞ KODU	ÜRÜN KODU	Kablo Kesiti mm ²	Civata Ø	Boyutlar (mm)						Kutu Miktarı (Adet)	BİRİM FİYATI \$
				d3	L	a	c	d1	S		
3532	KSNKYN-6-50	50	M6	18,0	34,0	16,0	17,0	11,0	1,8	100	2,074 \$
3533	KSNKYN-8-50		M8	18,0	34,0	16,0	17,0	11,0	1,8	100	2,075 \$
3534	KSNKYN-10-50		M10	18,0	34,0	16,0	17,0	11,0	1,8	100	2,075 \$
3535	KSNKYN-12-50		M12	22,0	36,0	16,0	17,0	11,0	1,8	100	2,247 \$
3536	KSNKYN-6-70	70	M6	22,0	38,0	18,0	21,0	13,0	2,0	50	2,793 \$
3537	KSNKYN-8-70		M8	22,0	38,0	18,0	21,0	13,0	2,0	50	2,873 \$
3538	KSNKYN-10-70		M10	22,0	38,0	18,0	21,0	13,0	2,0	50	3,032 \$
3539	KSNKYN-12-70		M12	22,0	38,0	18,0	21,0	13,0	2,0	50	3,032 \$
3540	KSNKYN-16-70		M16	22,0	38,0	18,0	21,0	13,0	2,0	50	3,032 \$
3541	KSNKYN-6-95	95	M6	24,0	42,0	20,0	23,0	15,0	2,5	50	4,256 \$
3542	KSNKYN-8-95		M8	24,0	42,0	20,0	23,0	15,0	2,5	50	4,335 \$
3543	KSNKYN-10-95		M10	24,0	42,0	20,0	23,0	15,0	2,5	50	4,335 \$
3544	KSNKYN-12-95		M12	24,0	42,0	20,0	23,0	15,0	2,5	50	4,335 \$
3545	KSNKYN-16-95		M16	24,0	42,0	20,0	23,0	15,0	2,5	50	4,482 \$
3546	KSNKYN-8-120	120	M8	24,0	44,0	22,0	24,0	16,5	3,0	25	5,985 \$
3547	KSNKYN-10-120		M10	24,0	44,0	22,0	24,0	16,5	3,0	25	5,985 \$
3548	KSNKYN-12-120		M12	24,0	44,0	22,0	24,0	16,5	3,0	25	5,985 \$
3549	KSNKYN-16-120		M16	24,0	44,0	22,0	24,0	16,5	3,0	25	6,720 \$
3550	KSNKYN-10-150	150	M10	30,0	50,0	24,0	28,0	19,0	3,2	20	10,310 \$
3551	KSNKYN-12-150		M12	30,0	50,0	24,0	28,0	19,0	3,2	20	10,310 \$
3552	KSNKYN-16-150		M16	30,0	50,0	24,0	28,0	19,0	3,2	20	10,310 \$
3553	KSNKYN-10-185	185	M10	36,0	50,0	28,0	33,0	21,0	3,5	20	13,960 \$
3554	KSNKYN-12-185		M12	36,0	50,0	28,0	33,0	21,0	3,5	20	13,960 \$
3555	KSNKYN-16-185		M16	36,0	50,0	28,0	33,0	21,0	3,5	20	13,960 \$
3556	KSNKYN-10-240	240	M10	36,0	50,0	28,0	33,0	21,0	3,5	20	18,900 \$
3557	KSNKYN-12-240		M12	36,0	50,0	28,0	33,0	21,0	3,5	20	18,900 \$
3558	KSNKYN-16-240		M16	36,0	50,0	28,0	33,0	21,0	3,5	20	18,100 \$

-duyar-
motorpompa®

Yenilikçi bina teknolojileri



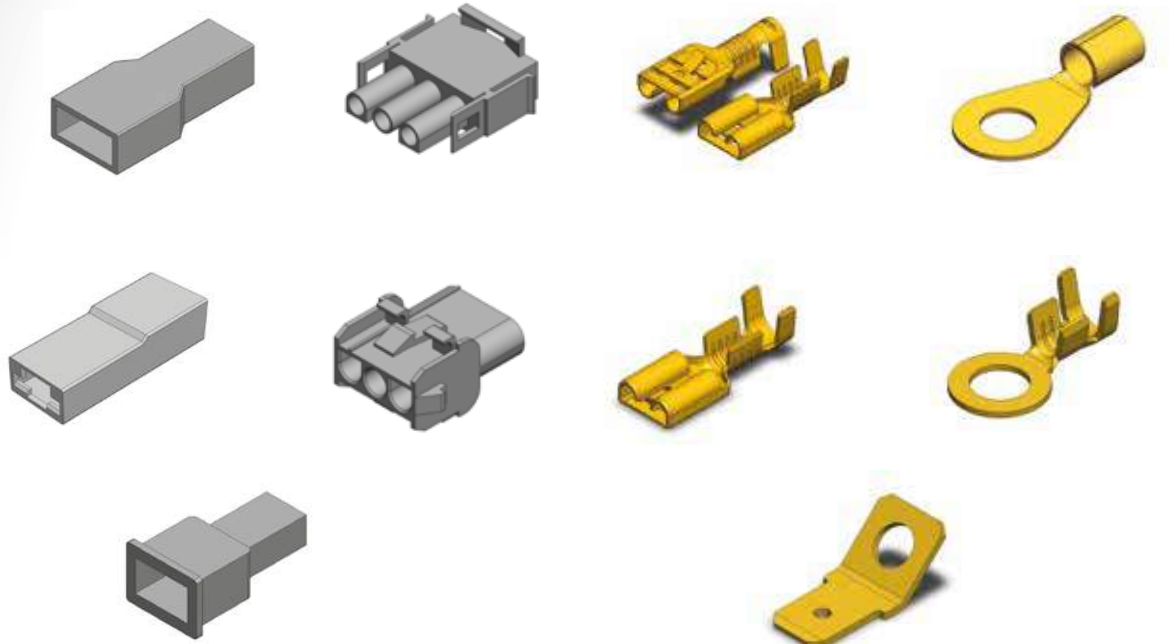







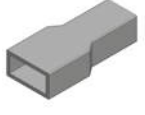

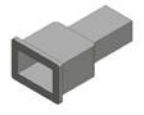

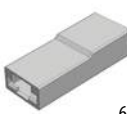









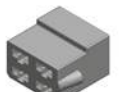

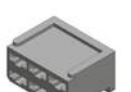

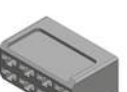

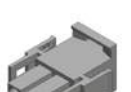



İZOLESİZ KABLO UÇLARI VE KONNEKTÖRLERİ



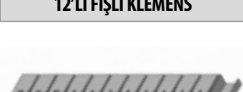

SF-1D  6,3 mm	SF-2D  6,3 mm	SF-1D MİNİ  4,8 mm	SF-1/2D  2,8 mm	SF-3D 	SF-1D EĞRİ 	SF-1D MİNİ EĞRİ 	SF-1DE  6,3 mm
SF-1DE MİNİ  4,8 mm	KRİMP 	SF-1D MİNİ TIRNAKLI  4,8 mm	SF-21D KİLİTLİ  6,3 mm	SF-23DKM KİLİTLİ  6,3 mm	SF-1EÇK 	SF-1EU1 	SF-12EU  2,8 mm
SK-2,5-04 	SK-4-04 	SK-6-06 	SW-4-04 	SW-5-05 	SKN-1-04 	SKN-2,5-04 	SKN-4-05 
SKN-6-06 	SKN-6-08 	SKN-10-08 	SKN-10-10 	SKN-10-12 	AVİZE TERMİNALİ 	SKN-1C 	SKN-2,5C 
SKN-4C 	SKN-6C 	SKF-8 	SF-4D 	SF-4E 	SWB BUJİ 	SF-22D 	SF-22E 
SFK-1-03  6,3 mm	SFK-1-03-45°  6,3 mm	SFK-1-03-90°  6,3 mm	SFK-1-04  6,3 mm	SFK-1-04-45°  6,3 mm	SFK-1-04-90°  6,3 mm	SFK-1-04-T  6,3 mm	SFK-1-05  6,3 mm
SFK-1-05-45°  6,3 mm	SFK-1-05-90°  6,3 mm	SFK-14  6,3 mm	SFK-25  6,3 mm	SFK-25 MİNİ  4,8 mm	SFK-35  6,3 mm	SFK-39  6,3 mm	SFK-43  6,3 mm
SFK-55  6,3 mm	BA-10 	BA-16 	BA-25 	BA-35 	BA-50 	BA-70 	BK-70 



SF-1D KILIF 	SF-1D KILIF PVC 	SF-1D MİNİ KILIF 	SF-3D KILIF 	SF-1E KILIF 
SF-1D EĞRİ PVC KILIF 	SF-1D EĞRİ KONNEKTÖR  6,3 mm	R2 TİPİ KONNEKTÖR  6,3 mm	R TİPİ KONNEKTÖR  4,8 mm	R TİPİ KONNEKTÖR  2,8 mm
101 ERKEK KONNEKTÖR 	101 DIŞI KONNEKTÖR 	201 ERKEK KONNEKTÖR 	201-T ERKEK KONNEKTÖR 	202 DIŞI KONNEKTÖR 
202-T DIŞI KONNEKTÖR 	301 ERKEK KONNEKTÖR 	302 DIŞI KONNEKTÖR 	401 ERKEK KONNEKTÖR 	402 DIŞI KONNEKTÖR 
601 ERKEK KONNEKTÖR 	602 ERKEK KONNEKTÖR 	801 ERKEK KONNEKTÖR 	802 DIŞI KONNEKTÖR 	SF-21D DIŞI KONNEKTÖR 
SF-22E 2'Lİ ERKEK KONNEKTÖR 	SF-22D 2'Lİ DIŞI KONNEKTÖR 	SF-22E 3'LÜ ERKEK KONNEKTÖR 	SF-22D 3'LÜ DIŞI KONNEKTÖR 	SF-22E 4'LÜ ERKEK KONNEKTÖR 
SF-22D 4'LÜ DIŞI KONNEKTÖR 	SF-22E 6'Lİ ERKEK KONNEKTÖR 	SF-22D 6'Lİ DIŞI KONNEKTÖR 	SF-22E 9'LÜ ERKEK KONNEKTÖR 	SF-22D 9'LÜ DIŞI KONNEKTÖR 
12'Lİ FİŞLİ KLEMENS 	4,8 PVC KILIF 	6,3 PVC KILIF 	4,8 EĞRİ PVC KILIF 	6,3 EĞRİ PVC KILIF 

ÜRÜN KODU	CİNSİ		AD. / ₺
HF-1D	Dişi Terminal	6,3 mm	1,800 ₺
HF-2D	Tırnaklı Diş Terminal	6,3 mm	1,630 ₺
HF-1D	Mini Dişi Terminal	4,8 mm	1,370 ₺
HF-½ D	Mikro Dişi Terminal	2,8 mm	1,070 ₺
HF-3D	Dişi Terminal		5,050 ₺
HF-1D	Eğri Dişi Terminal	6,3 mm	2,600 ₺
HF-1D	Mini Eğri Dişi Terminal	4,8 mm	2,300 ₺
HF-1DE	Dişi + Erkek Terminal	6,3 mm	4,540 ₺
HF-1D	DÇN Dişi Terminal	6,3 mm	1,450 ₺
HF-1E ÇK	Erkek Terminal	6,3 mm	1,950 ₺
HF-1EU1	Uzun Erkek Terminal	6,3 mm	2,000 ₺
HF-1E	Mini Erkek Terminal	4,8 mm	1,900 ₺
HF-½	Mikro Erkek Terminal	2,8 mm	1,900 ₺
HSK-2,5	Boru Tip Topraklama Terminali		1,370 ₺
HSK-4	Boru Tip Topraklama Terminali		2,430 ₺
HSK-6	Boru Tip Topraklama Terminali		2,520 ₺
HSW-4	Topraklama Terminali		1,170 ₺
HSKN-1	Topraklama Terminali		1,800 ₺
HSKN-2,5	Topraklama Terminali		1,820 ₺
HSKN-4	Topraklama Terminali		3,200 ₺
HSKN-6	Topraklama Terminali		4,850 ₺
HSKN-10	Topraklama Terminali		6,200 ₺
HSB-W	Buji Terminali TYD-2607		4,950 ₺
HSKN-1 C	Çatal Terminal		1,800 ₺
HSKN-2,5 C	Çatal Terminal		1,820 ₺
HSKN-4 C	Çatal Terminal		3,200 ₺
HSKN-6 C	Çatal Terminal		4,850 ₺
HSF-1D DPK	Kalaylı	6,3 mm	2,750 ₺
HSF-2D DPK	Kalaylı Tırnaklı	6,3 mm	2,550 ₺
HSF-1D B	Büyük ayak		2,290 ₺
HSF-1D K	Küçük ayak		1,800 ₺
TE-2346	SFK-8		4,950 ₺

ÜRÜN KODU	CİNSİ		AD. / ₺
HF-1D	Kılıf	6,3 mm	0,600 ₺
HF-1D	Renkli Kılıf	6,3 mm	0,650 ₺
HF-1D	Mini Kılıf	4,8 mm	0,600 ₺
HF-1E	Erkek Kılıf	6,3 mm	1,560 ₺
HF-3D	Kılıf	9,5 mm	1,800 ₺
R Tipi	Konnektör	6,3 mm	1,050 ₺
R Tipi	Konnektör	4,8 mm	1,175 ₺
R Tipi	Konnektör	2,8 mm	0,936 ₺
HF-1D	Eğri Konnektör	6,3 mm	2,400 ₺
BYT - 10	Bakır Top.Kablo Ucu		16,900 ₺
BYT - 16	Bakır Top.Kablo Ucu		24,000 ₺
BYT - 25	Bakır Top.Kablo Ucu		32,500 ₺
BYT - 35	Bakır Top.Kablo Ucu		51,500 ₺
BYT - 50	Bakır Top.Kablo Ucu		86,200 ₺
BYT - 70	Bakır Top.Kablo Ucu		146,500 ₺
41100	Telefon.Çatal Terminal		1,150 ₺
Mikro	Telefon Dişi Fiş 2,8 mm		1,170 ₺
TÖZ-2031	Kart Tipi DPK Dişi Terminal	6,3 mm	3,250 ₺
TD-2162	DPK Kart Tipi Dişi Terminal	6,3 mm	4,500 ₺
HSFK-25	Kart Tipi Erkek Terminal	6,3 mm	2,750 ₺
HSFK-35	Kart Tipi Erkek Terminal	6,3 mm	2,530 ₺
HSFK-39	Kart Tipi Erkek Terminal	6,3 mm	2,530 ₺
HSFK-43	Kart Tipi Erkek Terminal	6,3 mm	2,530 ₺
SFK-1-04	Toprak. Terminali TE-2339		3,080 ₺
HF-1D	DPG Dişi Terminal	6,3 mm	5,370 ₺
HF-2D	DPG Dişi Terminal	6,3 mm	5,370 ₺
HF-1EU1	DPG Uzun Erkek		6,720 ₺
TD-2160	DPK Kilitli Dişi Terminal	6,3 mm	7,800 ₺
TYD-2606	HF-4D Yuvarlak Dişi Term.		2,870 ₺
TYD-2704	HF-4E Yuvarlak Erkek Term.		2,880 ₺
	Kutup Başı Kılıfı		42,000 ₺

KYD-3801 / KYE-3901	1'Lİ DİŞİ ve ERKEK KONNEKTÖR	5,450 / AD. / ₺	10,900 / TK. / ₺
KYD-3802 / KYE-3902	2'Lİ DİŞİ ve ERKEK KONNEKTÖR	7,900 / AD. / ₺	15,800 / TK. / ₺
KYD-3803 / KYE- 3903	3'LÜ DİŞİ ve ERKEK KONNEKTÖR	9,300 / AD. / ₺	18,600 / TK. / ₺
KYD-3804 / KYE-3904	4'LÜ DİŞİ ve ERKEK KONNEKTÖR	12,800 / AD. / ₺	25,600 / TK. / ₺
KYD-3805 / KYE-3905	6'LI DİŞİ ve ERKEK KONNEKTÖR	14,000 / AD. / ₺	28,000 / TK. / ₺
KYD-3806 / KYE-3906	9'LU DİŞİ ve ERKEK KONNEKTÖR	21,000 / AD. / ₺	42,000 / TK. / ₺
KYD-3807 / KYE-3907	12'Lİ DİŞİ ve ERKEK KONNEKTÖR	27,500 / AD. / ₺	55,000 / TK. / ₺
KYD-3808 / KYE-3908	15'Lİ DİŞİ ve ERKEK KONNEKTÖR	30,300 / AD. / ₺	60,600 / TK. / ₺
TYE-2705 / SF-22 E	ERKEK TERMİNAL		3,700 ₺
TYD-2614 / SF-22 D	DİŞİ TERMİNAL		3,700 ₺

-duyar-
motorpompa®

Yenilikçi bina teknolojileri

Ø22 BUTON GRUBU & LED SİNYALLER





Sipariş Kodu	Ürün Kodu	Açıklama	Kontakt	Renk	Kutu Adedi	Birim Fiyatı (₺)
5001	KN-55-10	Start Yaylı Buton	1NO	Yeşil	10	120,00 ₺
5002	KN-55-01	Stop Yaylı Buton	1NC	Kırmızı	10	120,00 ₺
5003	KN-55-11	Start Yaylı Buton	1NO	Sarı	10	120,00 ₺
5004	KN-55-21	Start Yaylı Buton	1NO	Mavi	10	120,00 ₺
5005	KN-55-31	Start Yaylı Buton	1NO	Beyaz	10	120,00 ₺
5006	KN-55-41	Start Yaylı Buton	1NO	Siyah	10	120,00 ₺





Sipariş Kodu	Ürün Kodu	Açıklama	Kontakt	Renk	Kutu Adedi	Birim Fiyatı (₺)
5007	KN-55-10D	Işıklı Yaylı Buton 220V AC/DC	1NO	Yeşil	10	215,00 ₺
5008	KN-55-01D		1NC	Kırmızı	10	215,00 ₺
5009	KN-55-11D		1NO	Sarı	10	215,00 ₺
5010	KN-55-21D		1NO	Mavi	10	215,00 ₺
5011	KN-55-31D		1NO	Beyaz	10	215,00 ₺
5012	KN-55-10D-110	Işıklı Yaylı Buton 110V AC/DC	1NO	Yeşil	10	215,00 ₺
5013	KN-55-01D-110		1NC	Kırmızı	10	215,00 ₺
5014	KN-55-11D-110		1NO	Sarı	10	215,00 ₺
5015	KN-55-21D-110		1NO	Mavi	10	215,00 ₺
5016	KN-55-31D-110		1NO	Beyaz	10	215,00 ₺
5017	KN-55-10D-24	Işıklı Yaylı Buton 24V AC/DC	1NO	Yeşil	10	215,00 ₺
5018	KN-55-01D-24		1NC	Kırmızı	10	215,00 ₺
5019	KN-55-11D-24		1NO	Sarı	10	215,00 ₺
5020	KN-55-21D-24		1NO	Mavi	10	215,00 ₺
5021	KN-55-31D-24		1NO	Beyaz	10	215,00 ₺





KSN® Ø22 KALICI MANDAL BUTONLAR

İTHALATIMIZ

Sipariş Kodu	Ürün Kodu	Açıklama	Kontak	Kutu Adedi	Birim Fiyatı (₺)
5022	KN-55-10X	0-1 Mandal Buton 	1NO	10	140,00 ₺
5023	KN-55-20XS	1-0-2 Mandal Buton 	2NO	10	185,00 ₺



KSN® Ø22 KAYICI MANDAL BUTONLAR

İTHALATIMIZ

Sipariş Kodu	Ürün Kodu	Açıklama	Kontak	Kutu Adedi	Birim Fiyatı (₺)
5024	KN-55-10X/FU	0-1 Mandal Buton 	1NO	10	155,00 ₺
5025	KN-55-20XS/FU	1-0-2 Mandal Buton 	2NO	10	200,00 ₺

KSN® Ø22 ANAHTARLI KALICI BUTONLAR

İTHALATIMIZ

Sipariş Kodu	Ürün Kodu	Açıklama	Kontak	Kutu Adedi	Birim Fiyatı (₺)
5026	KN-55-10Y	0-1 Anahtarlı Buton 	1NO	10	200,00 ₺
5027	KN-55-20YS	1-0-2 Anahtarlı Buton 	2NO	10	250,00 ₺



Sipariş Kodu	Ürün Kodu	Açıklama	Kontak	Renk	Kutu Adedi	Birim Fiyatı (₺)
5028	KN-55-10XD	 0-1 Işıklı Mandal Buton 220V AC/DC	1NO	Yeşil	10	220,00 ₺
5029	KN-55-01XD		1NC	Kırmızı	10	220,00 ₺
5030	KN-55-11XD		1NO	Sarı	10	220,00 ₺
5031	KN-55-10XD-110	 0-1 Işıklı Mandal Buton 110V AC/DC	1NO	Yeşil	10	220,00 ₺
5032	KN-55-01XD-110		1NC	Kırmızı	10	220,00 ₺
5033	KN-55-11XD-110		1NO	Sarı	10	220,00 ₺
5034	KN-55-10XD-24	 0-1 Işıklı Mandal Buton 24V AC/DC	1NO	Yeşil	10	220,00 ₺
5035	KN-55-01XD-24		1NC	Kırmızı	10	220,00 ₺
5036	KN-55-11XD-24		1NO	Sarı	10	220,00 ₺
5037	KN-55-20XSD	 1-0-2 Işıklı Mandal Buton 220V AC/DC	2NO	Yeşil	10	265,00 ₺
5038	KN-55-02XSD		2NC	Kırmızı	10	265,00 ₺
5039	KN-55-21XSD		2NO	Sarı	10	265,00 ₺
5040	KN-55-20XSD-110	 1-0-2 Işıklı Mandal Buton 110V AC/DC	2NO	Yeşil	10	265,00 ₺
5041	KN-55-02XSD-110		2NC	Kırmızı	10	265,00 ₺
5042	KN-55-21XSD-110		2NO	Sarı	10	265,00 ₺
5043	KN-55-20XSD-24	 1-0-2 Işıklı Mandal Buton 24V AC/DC	2NO	Yeşil	10	265,00 ₺
5044	KN-55-02XSD-24		2NC	Kırmızı	10	265,00 ₺
5045	KN-55-21XSD-24		2NO	Sarı	10	265,00 ₺



Sipariş Kodu	Ürün Kodu	Açıklama	Kontak	Kutu Adedi	Birim Fiyatı (₺)
5046	KSN-LA-101	Start Kontakt	1NO	10	49,00 ₺
5047	KSN-LA-102	Stop Kontakt	1NC	10	49,00 ₺

KSN® Ø22 KALICI MANTAR BUTON (40mm)

İTHALATIMIZ



Sipariş Kodu	Ürün Kodu	Açıklama	Kontakt	Renk	Kutu Adedi	Birim Fiyatı (₺)
5048	KN-55-01ZS	Stop Mantar Buton	1NC	 Kırmızı	10	155,00 ₺

KSN® Ø22 KALICI ANAHTARLI MANTAR BUTON (40mm)

İTHALATIMIZ



Sipariş Kodu	Ürün Kodu	Açıklama	Kontakt	Renk	Kutu Adedi	Birim Fiyatı (₺)
5049	KN-BZ-01ZA	Anahtarlı Stop Mantar Buton	1NC	 Kırmızı	10	230,00 ₺

KSN® Ø22 KAYICI MANTAR BUTON (40mm)

İTHALATIMIZ





Sipariş Kodu	Ürün Kodu	Açıklama	Kontakt	Renk	Kutu Adedi	Birim Fiyatı (₺)
5050	KN-55-01M	Stop Mantar Buton	1NC	 Kırmızı	10	140,00 ₺

KSN® Ø22 İKİZ BUTON

İTHALATIMIZ



Sipariş Kodu	Ürün Kodu	Açıklama	Kontakt	Renk	Kutu Adedi	Birim Fiyatı (₺)
5051	KN-55-11R	İkiz Buton	1NO+1NC	 Yeşil - Kırmızı	10	220,00 ₺
5052	KN-55-11RD	Işıklı İkiz Buton 220V AC/DC	1NO+1NC	 Yeşil - Kırmızı	10	310,00 ₺
5053	KN-55-11RD-24	Işıklı İkiz Buton 24V AC/DC	1NO+1NC	 Yeşil - Kırmızı	10	310,00 ₺



Sipariş Kodu	Ürün Kodu	Açıklama	Renk	Kutu Adedi	Birim Fiyatı (₺)
5081	KSN-22-K	Led Sinyal 220V AC/DC	● Kırmızı	10	47,00 ₺
5082	KSN-22-Y		● Yeşil	10	47,00 ₺
5083	KSN-22-S		● Sarı	10	47,00 ₺
5084	KSN-22-M		● Mavi	10	47,00 ₺
5085	KSN-22-B		○ Beyaz	10	50,00 ₺
5086	KSN-22-110V-K	Led Sinyal 110V AC/DC	● Kırmızı	10	47,00 ₺
5087	KSN-22-110V-Y		● Yeşil	10	47,00 ₺
5088	KSN-22-110V-S		● Sarı	10	47,00 ₺
5089	KSN-22-110V-M		● Mavi	10	47,00 ₺
5090	KSN-22-110V-B		○ Beyaz	10	50,00 ₺
5091	KSN-22-24V-K	Led Sinyal 24V AC/DC	● Kırmızı	10	47,00 ₺
5092	KSN-22-24V-Y		● Yeşil	10	47,00 ₺
5093	KSN-22-24V-S		● Sarı	10	47,00 ₺
5094	KSN-22-24V-M		● Mavi	10	47,00 ₺
5095	KSN-22-24V-B		○ Beyaz	10	50,00 ₺

KSN® Ø22 mm LED'Lİ BUZZER (90 dB)

İTHALATIMIZ



Sipariş Kodu	Ürün Kodu	Açıklama	Renk	Kutu Adedi	Birim Fiyatı (₺)
5068	KSN-22DS/MS	Sesli Led Flaşör İkazlı 220V AC/DC	● Kırmızı	10	180,00 ₺
5069	KSN-22DS/MS24	Sesli Led Flaşör İkazlı 24V AC/DC	● Kırmızı	10	180,00 ₺

KSN® Ø22 mm VOLTMETRE

İTHALATIMIZ



Sipariş Kodu	Ürün Kodu	Açıklama	Renk	Kutu Adedi	Birim Fiyatı (₺)
5070	KSN-22-V-K	Ø 22 mm Led 24-450V Voltmetre	● Kırmızı	10	168,00 ₺
5071	KSN-22-V-Y		● Yeşil	10	168,00 ₺
5072	KSN-22-V-S		● Sarı	10	168,00 ₺
5073	KSN-22-V-M		● Mavi	10	168,00 ₺
5074	KSN-22-V-B		○ Beyaz	10	168,00 ₺

KSN® Ø22 mm AMPERMETRE

İTHALATIMIZ



Sipariş Kodu	Ürün Kodu	Açıklama	Renk	Kutu Adedi	Birim Fiyatı (₺)
5098	KSN-22-A-K	Ø 22 mm Led 100A Ampermetre	● Kırmızı	5	330,00 ₺
5099	KSN-22-A-Y		● Yeşil	5	330,00 ₺
5100	KSN-22-A-S		● Sarı	5	330,00 ₺
5101	KSN-22-A-M		● Mavi	5	330,00 ₺
5102	KSN-22-A-B		○ Beyaz	5	330,00 ₺

KSN® Ø 22 mm POTANSİYOMETRE

İTHALATIMIZ



Sipariş Kodu	Ürün Kodu	VOLTAJ	Açıklama	Kutu Adedi	Birim Fiyatı (₺)
5054	KSN22-5K	220V	5K Potansiyometre Tek Tur	10	230,00 ₺
5055	KSN22-10K	220V	10K Potansiyometre Tek Tur	10	230,00 ₺

KSN® MOTORLU SİREN

İTHALATIMIZ



Sipariş Kodu	Ürün Kodu	Açıklama	Kutu Adedi	Birim Fiyatı (₺)
5096	MS-190-220V	Ø 75 mm Metal Gövde 220 V AC Siren	10	730,00 ₺
5097	MS-190-24V	Ø 75 mm Metal Gövde 24 V AC Siren	10	730,00 ₺

KÖPRÜ DİYOT

Sipariş Kodu	ÜRÜN KODU	cinsi	AD. / \$
5201	KBPC 3510	35A 1000 V Köprü Diyot	1,00 \$
5202	KBPC 5010	50A 1000 V Köprü Diyot	1,25 \$

ST SERİSİ TERMİK SİGORTA

- 3A
- 5A
- 8A
- 10A
- 12A
- 15A
- 16A
- 20A
- 25A
- 30A
- 40A
- 50A

Sipariş Kodu	ÜRÜN KODU	AKIM	cinsi	AD. / \$
5203		3A - 20A		0,80 \$
5204		25A		0,90 \$
5205	HWA-271S	30A	125/250VAC 32 VDC	1,00 \$
5206		40A		2,20 \$
5207		50A		2,20 \$

KSN® ACİL STOP MANTAR BUTON KUTULU

İTHALATIMIZ



Sipariş Kodu	Ürün Kodu	Renk	Kontak	Açıklama	Kutu Adedi	Birim Fiyat TL
5056	KN-LA102-J174	Sarı/Siyah	1NC	Acil Stop Mantar Buton Kutulu	100	210,00 ₺

KSN® BOŞ KUMANDA KUTULARI

İTHALATIMIZ



Sipariş Kodu	Ürün Kodu	Renk	Açıklama	Kutu Adedi	Birim Fiyat TL
5057	KN-BOX-1	Sarı/Siyah	1'li Boş Kumanda Kutusu	100	80,00 ₺
5058	KN-BOX-2	Sarı/Siyah	2'li Boş Kumanda Kutusu	100	100,00 ₺
5059	KN-BOX-3	Sarı/Siyah	3'lü Boş Kumanda Kutusu	100	130,00 ₺
5060	KN-BOX-4	Sarı/Siyah	4'lü Boş Kumanda Kutusu	50	165,00 ₺
5061	KN-BOX-5	Sarı/Siyah	5'li Boş Kumanda Kutusu	50	240,00 ₺
5062	KN-BOX-6	Sarı/Siyah	6'lı Boş Kumanda Kutusu	50	240,00 ₺

Sipariş Kodu	Ürün Kodu	Açıklama	Kutu Adedi	Birim Fiyat TL
5063	KN	 22 mm Buton Rozeti (25 x h:22mm Etiket Ölçü)	100	6,60 ₺
5064	KN-60	 60 mm Acil Stop Etiketi	200	17,00 ₺
5065	KN-BK	 Acil Stop Buton Koruma Kapağı	16	110,00 ₺
5066	KN-BKK	 22 mm Buton Koruma Kapağı	16	90,00 ₺
5067	KN	 22 mm Buton Koruma Kılıfı	200	14,00 ₺

-duyar-
motorpompa®

Yenilikçi bina teknolojileri

DAĞITICI ÜNİTELER & KOMPAKT ÇOK AMAÇLI KLEMENSLER

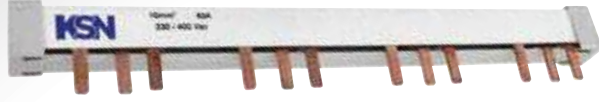

Ürün Kodu	KSN-80A	
Sipariş Kodu	6008	
Akım	80 A	
Kablo Kesit (mm²)	Giriş	Çıkış
	1x10-16 mm ²	4x2,5-6 mm ² 2x2,5-16 mm ²
Ambalaj	Paket	Koli
	5	250



Fiyatı (₺)

370,00 ₺

Ürün Kodu	KSN-125A	
Sipariş Kodu	6009	
Akım	125 A	
Kablo Kesit (mm²)	Giriş	Çıkış
	1x10-35 mm ²	6x2,5-16 mm ² KÖPRÜ 1x6-16 mm ²
Ambalaj	Paket	Koli
	5	160



Fiyatı (₺)

370,00 ₺

Ürün Kodu	KSN-160A	
Sipariş Kodu	6010	
Akım	160 A	
Kablo Kesit (mm²)	Giriş	Çıkış
	1x10-70 mm ²	6x2,5-16 mm ² KÖPRÜ 1x6-16 mm ²
Ambalaj	Paket	Koli
	5	160



Fiyatı (₺)

370,00 ₺

KSN® TEK KUTUPLU DAĞITICI ÜNİTELER

İTHALATIMIZ

Ürün Kodu	KSN-250A	
Sipariş Kodu	6011	
Akım	250 A	
Kablo Kesit (mm²)	Giriş	Çıkış
	1x35-120 mm ²	4x2,5-10 mm ² 5x2,5-16 mm ² 2x6-35 mm ²
Ambalaj	Paket	Koli
	3	54



Fiyatı (₺)

370,00 ₺

Ürün Kodu	KSN-400A	
Sipariş Kodu	6012	
Akım	400 A	
Kablo Kesit (mm²)	Giriş	Çıkış
	1x95-185 mm ²	4x2,5-10 mm ² 5x2,5-16 mm ² 2x6-35 mm ²
Ambalaj	Paket	Koli
	3	54



Fiyatı (₺)

370,00 ₺

Ürün Kodu	KSN-500A	
Sipariş Kodu	6013	
Akım	500 A	
Kablo Kesit (mm²)	Giriş	Çıkış
	8x24 mm ²	4x2,5-10 mm ² 5x2,5-16 mm ² 2x6-35 mm ²
Ambalaj	Paket	Koli
	3	54



Fiyatı (₺)

370,00 ₺

Ürün Kodu	KSN-DU-2x7	
Sipariş Kodu	6001	
Akım	125 A	
Kablo Cinsi	Tek Damar	Çok Telli
Kablo Kesit (mm²)	Giriş	Çıkış
	1x10-35 mm ²	1x10-25 mm ² 5x2,5-6 mm ²
	1x10-16 mm ²	1x6-16 mm ² 5x1,5-6 mm ²
Ambalaj	Paket	Koli
	1	100

L: 65 W:42 H:50 mm

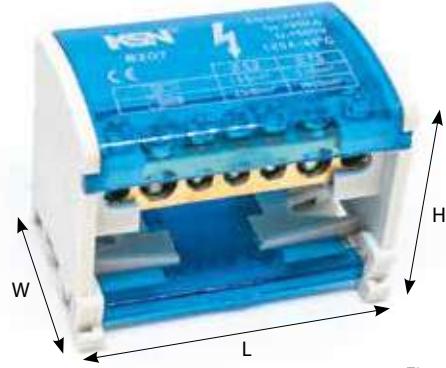

Fiyatı (₺)

370,00 ₺

Ürün Kodu	KSN-DU-2x11	
Sipariş Kodu	6002	
Akım	125 A	
Kablo Cinsi	Tek Damar	Çok Telli
Kablo Kesit (mm²)	Giriş	Çıkış
	2x10-35 mm ²	2x10-25 mm ² 7x2,5-6 mm ²
	2x10-16 mm ²	2x6-16 mm ² 7x1,5-6 mm ²
Ambalaj	Paket	Koli
	1	100

L: 100 W:42 H:50 mm

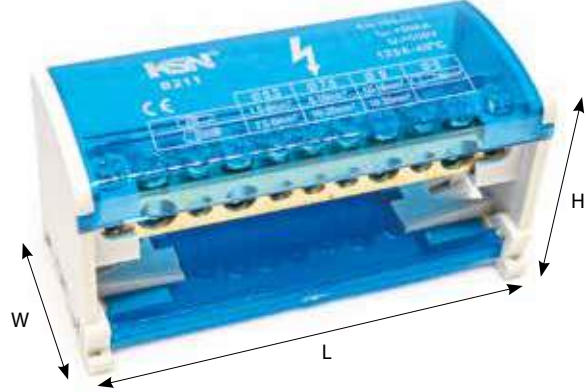

Fiyatı (₺)

530,00 ₺

Ürün Kodu	KSN-DU-2x15	
Sipariş Kodu	6003	
Akım	125 A	
Kablo Cinsi	Tek Damar	Çok Telli
Kablo Kesit (mm²)	Giriş	Çıkış
	2x10-35 mm ²	2x10-25 mm ² 11x2,5-6 mm ²
	2x10-16 mm ²	2x6-16 mm ² 11x1,5-6 mm ²
Ambalaj	Paket	Koli
	1	100

L: 135 W:42 H:50 mm

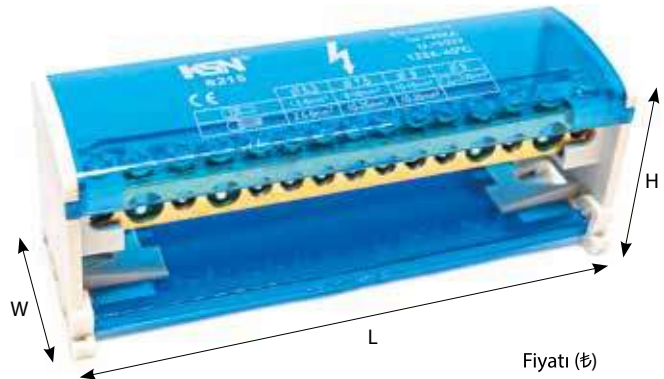

Fiyatı (₺)

680,00 ₺

KSN® 4 KUTUPLU DAĞITICI ÜNİTELER

İTHALATIMIZ

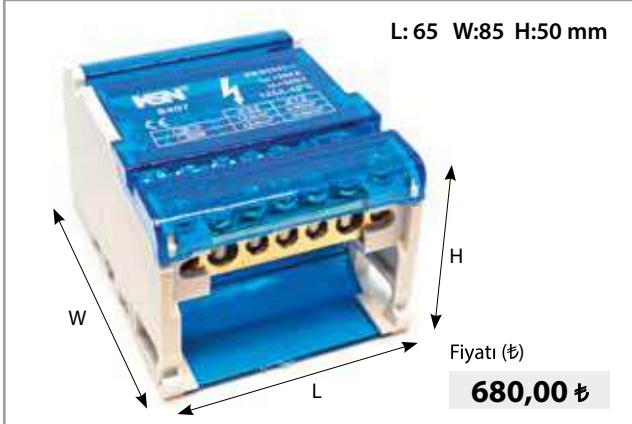

Ürün Kodu	KSN-DU-4x7	
Sipariş Kodu	6004	
Akım	125 A	
Kablo Cinsi	Tek Damar	Çok Telli
Kablo Kesit (mm ²)	Giriş	Çıkış
	1x10-35 mm ²	1x10-25 mm ² 5x2,5-6 mm ²
	1x10-16 mm ²	1x6-16 mm ² 5x1,5-6 mm ²
Ambalaj	Paket	Koli
	1	100

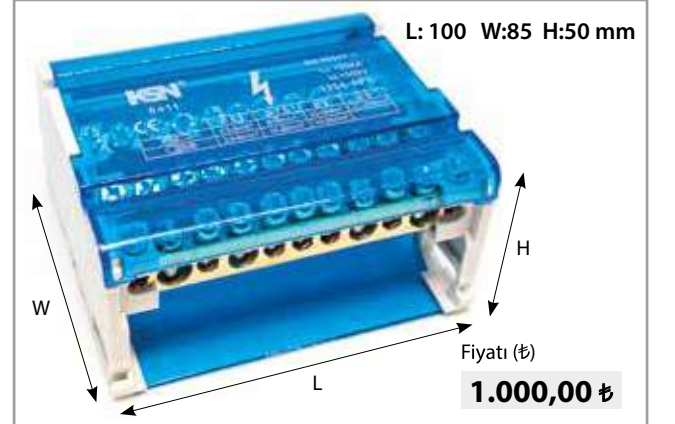

Ürün Kodu	KSN-DU-4x11	
Sipariş Kodu	6005	
Akım	125 A	
Kablo Cinsi	Tek Damar	Çok Telli
Kablo Kesit (mm ²)	Giriş	Çıkış
	2x10-35 mm ²	2x10-25 mm ² 7x2,5-6 mm ²
	2x10-16 mm ²	2x6-16 mm ² 7x1,5-6 mm ²
Ambalaj	Paket	Koli
	1	50

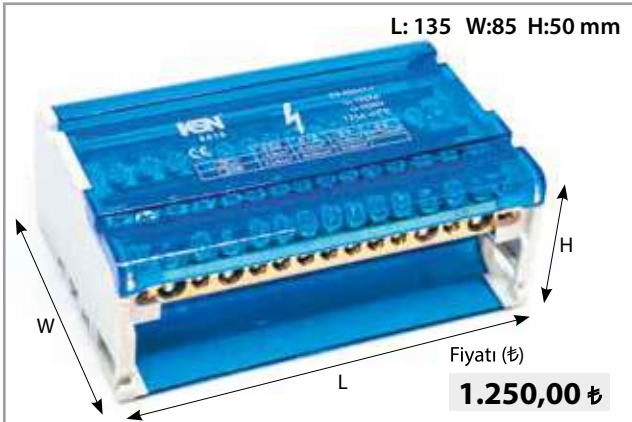

Ürün Kodu	KSN-DU-4x15	
Sipariş Kodu	6007	
Akım	125 A	
Kablo Cinsi	Tek Damar	Çok Telli
Kablo Kesit (mm ²)	Giriş	Çıkış
	2x10-35 mm ²	2x10-25 mm ² 11x2,5-6 mm ²
	2x10-16 mm ²	2x6-16 mm ² 11x1,5-6 mm ²
Ambalaj	Paket	Koli
	1	50

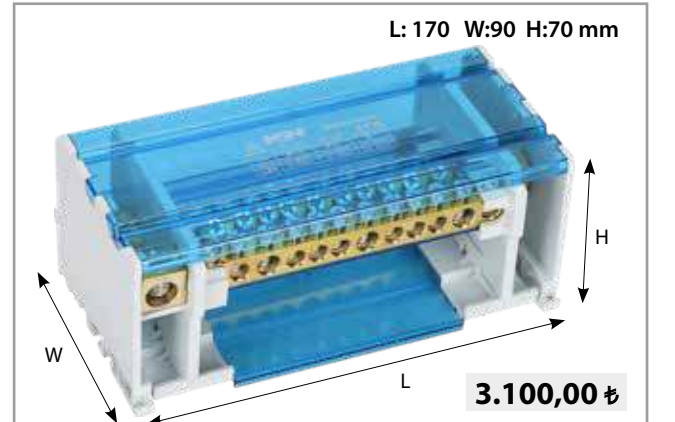

Ürün Kodu	KSN-DU-4x13/160A	
Sipariş Kodu	6006	
Akım	160 A	
Kablo Cinsi	Tek Damar	Çok Telli
Kablo Kesit (mm ²)	Giriş	Çıkış
	1x10-50 mm ²	3x10-35 mm ² 8x2,5-16 mm ²
	1x10-50 mm ²	3x6-25 mm ² 8x1,5-16 mm ²
Ambalaj	Paket	Koli
	1	20

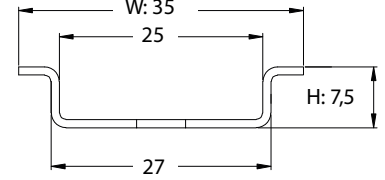
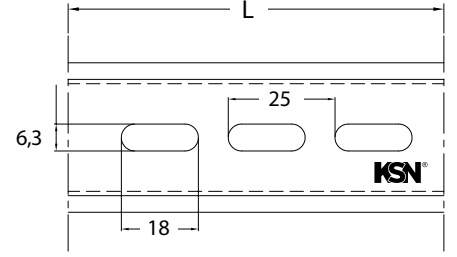

Sipariş Kodu	ÜRÜN KODU	ÖLÇÜ (L)	AÇIKLAMA	Kutu Miktarı (Adet)	BİRİM FİYATI ₺
6021	KSNRAY-001	30 cm	Delikli W Otomat Rayı	150	22,00 ₺
6022	KSNRAY-002	1 m	Delikli W Otomat Rayı	50	60,00 ₺
6023	KSNRAY-003	2 m	Delikli W Otomat Rayı	25	120,00 ₺

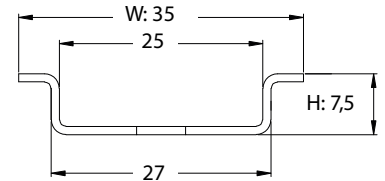
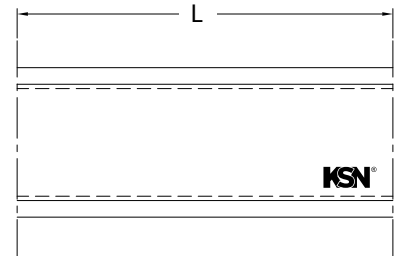
KSN® W OTOMAT RAYI**İMALATIMIZ**

Sipariş Kodu	ÜRÜN KODU	ÖLÇÜ (L)	AÇIKLAMA	Kutu Miktarı (Adet)	BİRİM FİYATI ₺
6024	KSNRAY-001	30 cm	W Otomat Rayı	150	22,00 ₺
6025	KSNRAY-002	1 m	W Otomat Rayı	50	60,00 ₺
6026	KSNRAY-003	2 m	W Otomat Rayı	25	120,00 ₺

KSN® TRİFAZE MÜŞTEREK W OTOMAT BARALARI

İMALATIMIZ

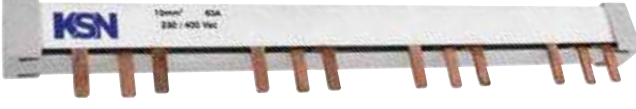

Sipariş Kodu	ÜRÜN KODU	ÖLÇÜ	BAKIR KALINLIĞI	AKIM (A)	MODÜL	Kutu Miktarı (Adet)	BİRİM FİYATI ₺
6043	KSNBR-013	53 cm	0,8 mm	63A	10	25	750,00 ₺
6044	KSNBR-014	106 cm	0,8 mm	63A	20	25	1.500,00 ₺
6031	KSNBR-001	53 cm	1 mm	80A	10	25	900,00 ₺
6032	KSNBR-002	106 cm	1 mm	80A	20	25	1.800,00 ₺
6033	KSNBR-003	53 cm	1,5 mm	100A	10	25	1.350,00 ₺
6034	KSNBR-004	106 cm	1,5 mm	100A	20	25	2.700,00 ₺

KSN® MONOFAZE MÜŞTEREK W OTOMAT BARALARI

İMALATIMIZ



Sipariş Kodu	ÜRÜN KODU	ÖLÇÜ	BAKIR KALINLIĞI	AKIM (A)	MODÜL	Kutu Miktarı (Adet)	BİRİM FİYATI ₺
6045	KSNBR-015	53 cm	0,8 mm	63A	10	25	240,00 ₺
6046	KSNBR-016	106 cm	0,8 mm	63A	20	25	480,00 ₺
6035	KSNBR-009	53 cm	1 mm	80A	30	50	300,00 ₺
6036	KSNBR-010	106 cm	1 mm	80A	60	50	600,00 ₺
6037	KSNBR-011	53 cm	1,5 mm	100A	30	50	450,00 ₺
6038	KSNBR-012	106 cm	1,5 mm	100A	60	50	900,00 ₺

KSN® NÖTR VİDALI TOPRAKLAMA BARALARI

İMALATIMIZ



Sipariş Kodu	ÜRÜN KODU	MODÜL	BAKIR KALINLIĞI	Kutu Miktarı (Adet)	BİRİM FİYATI ₺
6039	KSNBR-005	31 Vida	1,5 x 15,0	20	
6040	KSNBR-006	61 Vida	1,5 x 15,0	20	
6041	KSNBR-007	31 Vida	2,0 x 15,0	20	
6042	KSNBR-008	61 Vida	2,0 x 15,0	20	

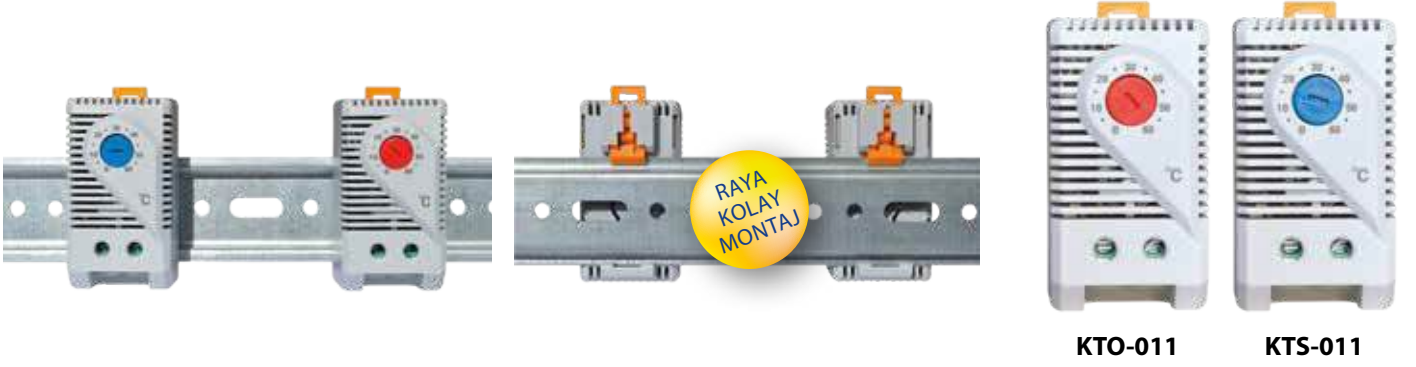

Sipariş Kodu	ÜRÜN KODU	AÇIKLAMA	KONTAK TİPİ	ÇALIŞMA ÖMRÜ (Açma-Kapama)	ÖLÇÜLER (mm)	KUTU MİKTARI (ADET)	BİRİM FİYATI (\$)
6051	KTO-011	Isıtma Termostatu (0-60 °C)	Kapalı	100.000	60 x 33 x 43	10	6,00 \$
6052	KTS-011	Soğutma Termostatu (0-60 °C)	Açık	100.000	60 x 33 x 43	10	6,00 \$

KSN® UNIVERSAL SAYICILAR

Sipariş Kodu	ÜRÜN KODU	AÇIKLAMA	Sıfırlama	Dijital Hane Sayısı	Rakam Ölçüsü (mm)	Montaj Boyutu (mm)	Maks. Hesaplama Hızı	BİRİM FİYATI (\$)
6061	RS 102 - 5 V1	Darbeli Turmetre	Çevirerek	5	3,5 x 5	37 x 30 x Ø 4,1	600 / Devir	7,50 \$
6062	RS 102 - 5 V2	Darbeli Turmetre	Basmalı	5	3,5 x 5	37 x 30 x Ø 4,1	600 / Devir	11,50 \$
6063	LB 102 - 5 V1	Dönmeli Turmetre	Çevirerek	5	3,5 x 5	37 x 30 x Ø 4,1	4.000 / Devir	8,00 \$
6064	LB 102 - 5 V2	Dönmeli Turmetre	Basmalı	5	3,5 x 5	37 x 30 x Ø 4,1	4.000 / Devir	12,00 \$
6065	BM3 10 - 5	Tekstilci Turmetresi	Basmalı	5	4,5 x 6,5	62,5 x 52 x Ø 4,2	30 m / Dakika	105,00 \$

-duyar-
motorpompa®

Yenilikçi bina teknolojileri

EL ALETLERİ GRUBU

KSN®
EL ALETLERİ



KSN® MEKANİK EL ALETLERİ (Yüksük Sıkma)

İTHALATIMIZ

FC-5 (YAC-5) | 0,50 - 6 mm²
Yüksük Sıkma PensesiSipariş Kodu
7001**75,00 \$****FC-6 (YAC-6)** | 6 - 16 mm²
Yüksük Sıkma PensesiSipariş Kodu
7002**75,00 \$****FC-8 (YAC-8)** | Dörtgen / 0,08 - 6 mm²
Yüksük Sıkma PensesiSipariş Kodu
7003**97,00 \$****FC-9 (YAC-9)** | Altıgen / 0,08 - 6 mm²
Yüksük Sıkma PensesiSipariş Kodu
7004**112,00 \$****FT-B4 (YYT-B4)** | 0,50 - 6 mm²
Yüksük Sıkma PensesiSipariş Kodu
7005**70,00 \$****FT-B6 (YYT-B6)** | 6 - 10 - 16 mm²
Yüksük Sıkma PensesiSipariş Kodu
7006**71,00 \$****FT-B7 (YYT-B7)** | 0,14 - 2,5 mm²
Yüksük Sıkma PensesiSipariş Kodu
7007**72,00 \$****FC-17 (YAC-17)** | 25 - 35 mm²
Yüksük Sıkma PensesiSipariş Kodu
7008**78,00 \$****FR-16** | 0,50 - 16 mm²
Yüksük Sıkma PensesiSipariş Kodu
7009**38,00 \$****NWS-16** | 0,50 - 16mm²
Yüksük Sıkma PensesiSipariş Kodu
7010**90,00 €****MADE IN GERMANY**

KSN® MEKANİK EL ALETLERİ (İzoleli ve İzolesiz)

İTHALATIMIZ

HD-0560 | 0,5 - 6 mm²
İzoleli Papuç Sıkma Pensesi

Sipariş Kodu
7011



78,00 \$

FT-7 (YYT-7) | 0,5 - 6 mm²
İzoleli Papuç Sıkma Pensesi

Sipariş Kodu
7012



76,00 \$

FT-1 (YYT-1) | 0,5 - 10 mm²
İzoleli Papuç Sıkma Pensesi

Sipariş Kodu
7013



63,00 \$

HD-FLAG | 0,5 - 2,5 mm²
Bayrak Tip İzoleli Term. Pensesi

Sipariş Kodu
7014

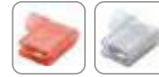

90,00 \$

HD-F 0560 | 0,50 - 6 mm²
İzolesiz Terminal Sıkma Pensesi

Sipariş Kodu
7015



78,00 \$

FT-11 (YYT-11) | 0,50 - 6 mm²
İzolesiz Terminal Sıkma Pensesi

Sipariş Kodu
7016



76,00 \$

FT-12 (YYT-12) | 1,5 - 2,5 / 4 - 6 / 8 - 10 mm²
İzolesiz Terminal Sıkma Pensesi

Sipariş Kodu
7017



77,00 \$

FC-16 (YAC-16) | 1,5 - 2,5 mm²
Eğri Terminal Sıkma Pensesi

Sipariş Kodu
7018



90,00 \$

FT-8 (YYT-8) | 1,5 - 10 mm²
SKP Sıkma Pensesi

Sipariş Kodu
7019



66,00 \$

FT-9 (YYT-9) | 10 - 16 mm²
SKP Sıkma Pensesi

Sipariş Kodu
7020



66,00 \$

KSN® MEKANİK EL ALETLERİ (SKP ve İzolesiz)

İTHALATIMIZ

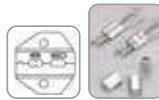
FT-15 (YYT-15) | Kablo Kapama
Sıkma Pensesi - AWG 10-12Sipariş Kodu
7021**90,00 \$****FC-12 (YAC-12)** | 28 - 22 / 22 - 18 (AWG) (JST)
Konnektör Ucu Sıkma PensesiSipariş Kodu
7022**79,00 \$****FC-13 (YAC-13)** | 28 - 22 / 24 - 18 (AWG) (Molex)
Konnektör Ucu Sıkma PensesiSipariş Kodu
7023**79,00 \$****HD-11010** | 24 - 14 (AWG)
Konnektör Sıkma PensesiSipariş Kodu
7024**78,00 \$****FC-4 (YAC-4)** | 18 - 22 / 24 - 30 (AWG)
Konnektör Terminal PensesiSipariş Kodu
7025**76,00 \$****HD-11011** | 30 - 18 (AWG)
Konnektör Sıkma PensesiSipariş Kodu
7026**78,00 \$****FT-B10 (YYT-B10)** | 0,08 - 0,8 mm² (AWG)
28 - 18 Konnektör Term. Pens.Sipariş Kodu
7027**74,00 \$****HD - SWLK** | Çelik Tel Kilitleme
Konnektör PensesiSipariş Kodu
7028**95,00 \$****HY-204J** | 2,5 - 6 mm²
Kablo Kesme MakasıSipariş Kodu
7065**18,00 \$****HY-204P** | 2,5 - 6 mm²
Kablo Kesme MakasıSipariş Kodu
7067**18,00 \$**

KSN® KABLO SOYMA VE KESME ALETLERİ

İTHALATIMIZ

CC-08 | 10 mm² Kablo Kesme MakasıSipariş Kodu
7034**25,00 \$****CC-60** | 60 mm² Bakır ve Alüminyum Kablo KeserSipariş Kodu
7035**50,00 \$****CC-38 S** | 38 mm² Bakır ve Alüminyum Kablo KeserSipariş Kodu
7036**40,00 \$****CC-250** | 250 mm² Bakır ve Alüminyum Kablo KeserSipariş Kodu
7037**196,00 \$****FR-C80** | 80 mm² Bakır ve Alüminyum Kablo KeserSipariş Kodu
7038**66,00 \$****CC-500** | 500 mm² Bakır ve Alüminyum Kablo KeserSipariş Kodu
7039**320,00 \$****KSN® NETWORK PENSELERİ**

İTHALATIMIZ

HY-376E | 8P8C / 6P6C / 6P4C Plug Sıkma PensesiSipariş Kodu
7040**38,00 \$****HT-200** | Modüller (4P-4C), (6P-6C), (8P-8C) Plug Sıkma PensesiSipariş Kodu
7041**20,00 \$****KD-1** | 1 - 6 mm² İrtibatlama AletiSipariş Kodu
7042**10,00 \$****EZ-1** | 8P8C/RJ-45, 6P6C/RJ-11 ve 6P4C/RJ-12 Yeni Nesil Konnektör PensesiSipariş Kodu
7043**45,00 \$**

KSN® KABLO SOYMA VE KESME ALETLERİ

İTHALATIMIZ

F-318 (YY-78/318) | 0,50 - 6 mm²
Kablo Soyma PensesiSipariş Kodu
7029**36,00 \$****KP-6** | 0,8 - 6 mm²
Kablo Soyma PensesiSipariş Kodu
7030**62,00 \$****HY-150A** | 0,50 - 6 mm²
Kablo Soyma PensesiSipariş Kodu
7033**22,00 \$****TP-700B** | 0,8 - 2,0 - 3,5 - 5,5 - 8 mm²
Çoklu Kablo Soyma PensesiSipariş Kodu
7032**54,00 \$****HY-371** | 0,20 - 6 mm²
Kablo Soyma ve Sıkma PensesiSipariş Kodu
7066**30,00 \$****HY-223H** | 2 mm²
Kablo Soyma ve Kesme PensesiSipariş Kodu
7064**15,00 \$****HY-033** | 0,75 - 6 mm²
Kablo Soyma ve Sıkma PensesiSipariş Kodu
7062**11,00 \$****HY-5022** | 0,40 - 1,3 mm²
Kablo Soyma ve Kesme PensesiSipariş Kodu
7063**18,00 \$****KSN-WT-2** | Kablo Kanalı Kesme MakasıSipariş Kodu
7068

- Tüm kablo kanalı ve plastik kanalda düz ve 45° lik açısı yapmanızı sağlar.
- Plastik boru ve spiral boru kesebilir.
- Emniyet kilit kapağı mevcuttur.

**-,00 \$**

KSN® KABLOBAĞI SIKMA PENSELERİ

İTHALATIMIZ

TG-0082,2 - 4,8 mm
Kablo Bağı Sıkma PensesiSipariş Kodu
7044**72,00 \$****TG-009**3,6 - 9,0 mm
Kablo Bağı Sıkma PensesiSipariş Kodu
7045**51,00 \$****TG-011**4,6 - 12 mm
Çelik Kablo Bağı Sıkma PensesiSipariş Kodu
7046**200,00 \$****LY-600N**4,8 - 7,6 mm
Çelik Kablo Bağı Sıkma PensesiSipariş Kodu
7047**220,00 \$**
EL ALETLERİ

YETKİLİ BAYI

JOKARI-102800,4 - 28 mm² arası
NYY-NYM
Yuvarlak Kablo SoymaSipariş Kodu
7048**47,00 €****JOKARI-10282**0,4 - 28 mm² arası
NYY-NYM
Yuvarlak Kablo SoymaSipariş Kodu
7049**38,00 €****JOKARI-20050**1 - 6 mm²
Kablo Soyma PensesiSipariş Kodu
7050**74,00 €****TRE-03NB**

Elektronikçi Yan Keski

Sipariş Kodu
7051**9,30 €**

KSN® MEKANİK SKP PAPUÇ SIKMA PENSELERİ

İTHALATIMIZ

KSN-0650 | 6,0 - 50 mm²
SKP Sıkma Pensesi (Döner Çene)Sipariş Kodu
7052

-,00 \$

KSN-10120 | 10,0 - 120 mm²
SKP Sıkma Pensesi (Döner Çene)Sipariş Kodu
7053

-,00 \$

KSN-25150 | 25 - 150 mm²
SKP Sıkma PensesiSipariş Kodu
7054

-,00 \$

FR-25 (YYR-510) | 8,0 - 25 mm²
SKP Sıkma PensesiSipariş Kodu
7055

95,00 \$

ZUPPER HİDROLİK PAPUÇ SIKMA PENSELERİ

İTHALATIMIZ

YQK-70 | 4 - 70 mm² Hidrolik Alüminyum ve Bakır
Kablo Papuç Sıkma PensesiSipariş Kodu
7056

125,00 \$

YYQ-120A | 10 - 120 mm² Hidrolik Alüminyum
ve Bakır Kablo Papuç Sıkma PensesiSipariş Kodu
7057

155,00 \$

YYQ-120 | 10 - 120 mm² Hidrolik Alüminyum
ve Bakır Kablo Papuç Sıkma PensesiSipariş Kodu
7058

150,00 \$

YQK-300 | 10 - 300 mm² Hidrolik Alüminyum
ve Bakır Kablo Papuç Sıkma PensesiSipariş Kodu
7059

160,00 \$

HZ-300 | 16 - 300 mm² Hidrolik Alüminyum
ve Bakır Kablo Papuç Sıkma PensesiSipariş Kodu
7060

1.250,00 \$

HZ-400 | 16 - 400 mm² Hidrolik Alüminyum
ve Bakır Kablo Papuç Sıkma PensesiSipariş Kodu
7061

1.450,00 \$

No. 4-28 H | 4 - 28 mm Ø
Kablo Soyucu

Sipariş Kodu
7101



36,00 €

No. 300 | 0,5 - 6 mm²
Duo-Soyucu

Sipariş Kodu
7102



139,00 €

No. 5 | 0,2 - 6 mm²
Kablo Sıyırıcı

Sipariş Kodu
7103



56,00 €

No. 5 Pro | 0,2 - 16 mm²
Kablo Sıyırıcı

Sipariş Kodu
7104



109,00 €

10100025 | 50 mm²'ye kadar
Kablo Makası XL

Sipariş Kodu
7105



42,00 €

10068090 | Düz ve Yuvarlak Kablo Soyucu

Sipariş Kodu
7106



32,00 €

10100513 | Altıgen / 0,5 - 16 mm²
Yüksük Sıkma Pensi HEX

Sipariş Kodu
7107



120,00 €

10100515 | 0,25 - 6 mm²
Yüksük Sıkma Pensi MULTI

Sipariş Kodu
7108



160,00 €

10100516 | 0,25 - 6 mm²
Yüksük Sıkma Pensi ERGO

Sipariş Kodu
7109



212,00 €

No. 4 - 29 | 4,5 - 29 mm
Kablo Soyucu Spiral

Sipariş Kodu
7110



187,00 €

03 KOMBİNE PENSELER

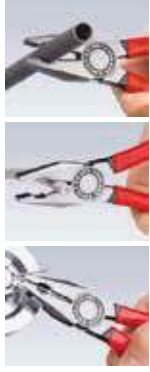

SIPARIŞ KODU	UZUNLUK mm	KAFA	SAP	KESME KAPASİTESİ					FİYATI €
				Ømm	Ømm	Ømm	mm²	gr	
7121	140	Polisaj	İnce izole	2,8	1,8	9,0	10	112	23,00
7122	160			3,1	2,0	10,0	16	187	21,00
7123	180			3,4	2,2	12,0	16	216	22,00
7124	160	Polisaj	Kalın izole	3,1	2,0	10,0	16	223	27,00
7125	180			3,4	2,2	12,0	16	260	28,00
7126	200			3,8	2,5	13,0	16	330	32,00

12 OTOMATİK KABLO SIYIRICI

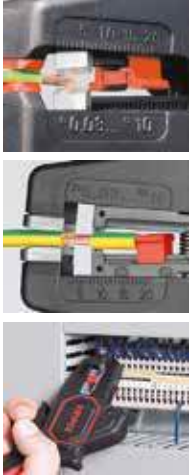

SIPARIŞ KODU	UZUNLUK mm	SIYIRMA KAPASİTESİ		ÖZELLİK	gr	FİYATI €
		mm²	AWG			
7127	200	0.03-10.0	32-7	Manuel derinlik ayarlamalı	200	101,00
7128	200	2.5-16.0	13-7	Manuel derinlik ayarlamalı	200	146,00
7129	195	0.03-10.0	32-7	Otomatik derinlik ayarlamalı	136	135,00
7130	180	0.2-6.0	24-10	Otomatik derinlik ayarlamalı	151	59,00

97 YÜKSÜK SIKMA PENSİ



SIPARIŞ KODU	UZUNLUK mm	FORM	SAP	KULLANMA YERİ	KAPASİTE	gr	FİYATI €
7132	180	◆	Kalın izole	Kablo ucu altı köşe papuç sıkma	0.08-10mm²	404	251,00
7133	190	◆	Kalın izole	Kablo ucu dört köşe papuç sıkma	0.08-10/16mm²	486	257,00

97 TELEFON ve JAK BALANTI PENSELERİ

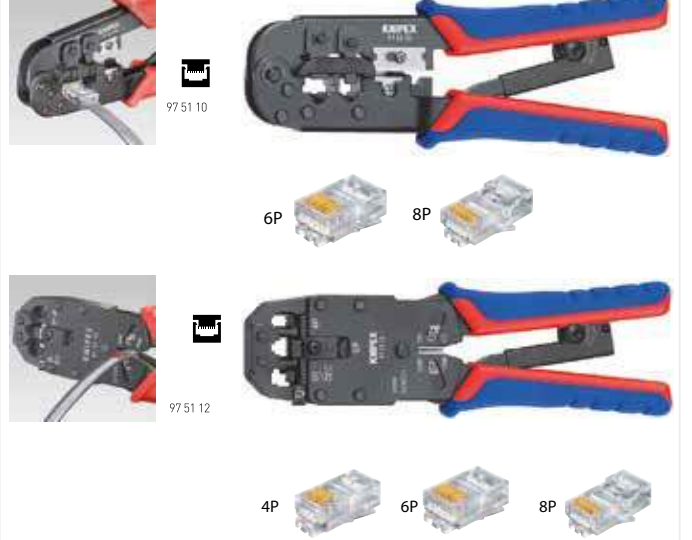

SIPARIŞ KODU	UZUNLUK mm	SAP	KULLANMA YERİ	KAPASİTE	gr	FİYATI €
7145	190	zole	Telefon konnektör kablo bağlantılar	RJ11/12(6P) RJ45(8BP)	340	55,70
7146	200	zole	Telefon konnektör kablo bağlantılar	RJ10(4P) RJ11/12(6P) RJ45(8P)	522	193,20

70 YAN KESKİ



SIPARIŞ KODU	UZUNLUK (mm)	FORM	KAFA	SAP	KESME DEĞERLERİ			gr	FİYATI €
					Ømm	Ømm	Ømm		
7134	110	◆	Polisaj	İnce izole	3,0	2,0	1,2	80	27,00
7135	125				3,0	2,3	1,5	80	27,00
7136	160				4,0	2,8	2,0	171	27,00
7137	125				3,0	2,3	1,5	115	33,91
7138	140				4,0	2,5	1,8	155	35,00
7139	160				4,0	2,8	2,0	205	34,00
7140	180	4,0	3,0	2,5	235	36,00			
7141	125	1000V	Krom	Sarı kırmızı çift bilesimli	3,0	2,3	1,5	120	43,00
7142	140				4,0	2,5	1,8	160	43,00
7143	160				4,0	2,8	2,0	205	46,00
7144	180				4,0	3,0	2,5	255	49,00

KONDANSATÖR GRUBU

-duyar-
motorpompa®

Yenilikçi bina teknolojileri



KONDANSATÖR
CAPACITOR



DAİMİ DEVRE MOTOR KONDANSATÖRLERİ**KONDANSATÖR**
CAPACITOR

HAWCON Sipariş Kodu	EDE Sipariş Kodu	KAPASİTE CBB 60	VOLT	Ölçüler (mm)	Pls. Tüp Kablolu 400/450V Adet / (\$)
8001	8051	0,5 µf	400 - 450 V	25 x 65	1,00 \$
8002	8052	1 µf	400 - 450 V	25 x 65	1,00 \$
8003	8053	1,25 µf	400 - 450 V	25 x 65	1,02 \$
8004	8054	1,5 µf	400 - 450 V	25 x 65	1,03 \$
8005	8055	2 µf	400 - 450 V	25 x 65	1,05 \$
8006	8056	2,5 µf	400 - 450 V	25 x 65	1,11 \$
8007	8057	3 µf	400 - 450 V	25 x 65	1,12 \$
8008	8058	3,15 µf	400 - 450 V	25 x 65	1,14 \$
8009	8059	3,5 µf	400 - 450 V	25 x 65	1,14 \$
8010	8060	4 µf	400 - 450 V	25 x 65	1,16 \$
8011	8061	4,5 µf	400 - 450 V	30 x 65	1,17 \$
8012	8062	5 µf	400 - 450 V	30 x 63	1,20 \$
8013	8063	6 µf	400 - 450 V	30 x 63	1,35 \$
8014	8064	6,3 µf	400 - 450 V	30 x 63	1,40 \$
8015	8065	6,5 µf	400 - 450 V	30 x 63	1,40 \$
8016	8066	7 µf	400 - 450 V	30 x 63	1,45 \$
8017	8067	7,5 µf	400 - 450 V	30 x 63	1,46 \$
8018	8068	8 µf	400 - 450 V	30 x 63	1,60 \$
8019	8069	9 µf	400 - 450 V	30 x 63	1,76 \$
8020	8070	10 µf	400 - 450 V	34 x 63	1,77 \$
8021	8071	12 µf	400 - 450 V	34 x 71	1,82 \$
8022	8072	12,5 µf	400 - 450 V	34 x 71	1,85 \$
8023	8073	14 µf	400 - 450 V	34 x 71	2,35 \$
8024	8074	15 µf	400 - 450 V	34 x 71	2,45 \$
8025	8075	16 µf	400 - 450 V	34 x 71	2,50 \$
8026	8076	18 µf	400 - 450 V	40 x 72	2,52 \$
8027	8077	20 µf	400 - 450 V	40 x 72	2,56 \$
8028	8078	25 µf	400 - 450 V	40 x 72	3,00 \$
8029	8079	30 µf	400 - 450 V	44 x 72	3,45 \$
8030	8080	32 µf	400 - 450 V	44 x 72	3,75 \$
8031	8081	35 µf	400 - 450 V	44 x 72	3,85 \$
8032	8082	40 µf	400 - 450 V	44 x 95	4,25 \$
8033	8083	45 µf	400 - 450 V	44 x 95	4,66 \$
8034	8084	50 µf	400 - 450 V	48 x 95	4,95 \$
8035	8085	55 µf	400 - 450 V	48 x 102	5,25 \$
8036	8086	60 µf	400 - 450 V	48 x 102	5,66 \$
8037	8087	65 µf	400 - 450 V	48 x 102	6,75 \$
8038	8088	70 µf	400 - 450 V	55 x 123	7,50 \$
8039	8089	80 µf	400 - 450 V	55 x 123	7,75 \$
8040	8090	85 µf	400 - 450 V	55 x 123	8,90 \$
8041	8091	90 µf	400 - 450 V	55 x 123	9,30 \$
8042	8092	100 µf	400 - 450 V	58 x 123	9,80 \$

DAİMİ DEVRE MOTOR KONDS. PLASTİK TÜP VİDALI, TERMINALLİ



KONDANSATÖR
CAPACITOR



HAWCON Sipariş Kodu	KAPASİTE CBB 60	VOLT	Ölçü (mm) Ebatları	Birim Fiyat AD. (\$)
8396	0,5 µf	400 - 450 V	30 x 57	1,10 \$
8397	1 µf	400 - 450 V	30 x 57	1,10 \$
8398	1,5 µf	400 - 450 V	30 x 57	1,15 \$
8399	2 µf	400 - 450 V	30 x 57	1,25 \$
8400	2,5 µf	400 - 450 V	30 x 57	1,30 \$
8401	3 µf	400 - 450 V	30 x 57	1,40 \$
8402	3,15 µf	400 - 450 V	30 x 57	1,43 \$
8403	4 µf	400 - 450 V	35 x 65	1,45 \$
8404	4,5 µf	400 - 450 V	35 x 65	1,48 \$
8405	5 µf	400 - 450 V	35 x 65	1,55 \$
8406	6 µf	400 - 450 V	35 x 65	1,70 \$
8407	7 µf	400 - 450 V	35 x 65	1,75 \$
8408	7,5 µf	400 - 450 V	35 x 65	1,80 \$
8409	8 µf	400 - 450 V	35 x 65	1,85 \$
8410	9 µf	400 - 450 V	35 x 65	2,19 \$
8411	10 µf	400 - 450 V	35 x 65	2,20 \$
8412	12,5 µf	400 - 450 V	40 x 70	2,60 \$
8413	15 µf	400 - 450 V	40 x 70	2,82 \$
8414	16 µf	400 - 450 V	40 x 70	2,94 \$
8415	18 µf	400 - 450 V	40 x 70	3,16 \$
8416	20 µf	400 - 450 V	40 x 70	3,26 \$
8417	25 µf	400 - 450 V	45 x 95	3,66 \$
8418	30 µf	400 - 450 V	45 x 95	4,21 \$
8419	35 µf	400 - 450 V	50 x 106	4,71 \$
8420	40 µf	400 - 450 V	50x 106	5,32 \$
8421	45 µf	400 - 450 V	50 x 106	5,97 \$
8422	50 µf	400 - 450 V	50 x 106	6,42 \$
8423	55 µf	400 - 450 V	50 x 106	6,95 \$
8424	60 µf	400 - 450 V	50 x 106	7,23 \$
8425	70 µf	400 - 450 V	50 x 116	9,40 \$
8426	80 µf	400 - 450 V	60 x 120	10,50 \$
8427	90 µf	400 - 450 V	60 x 120	12,50 \$
8428	100 µf	400 - 450 V	60 x 120	14,00 \$

PLASTİK TÜP, VİDALI, KABLOLU

HAWCON Sipariş Kodu	KAPASİTE CBB 61	VOLT	Ölçü (mm) Ebatları	Birim Fiyat AD. (\$)
8101	1 µf	400 - 450 V	30 x 65	1,50 \$
8102	1,5 µf	400 - 450 V	30 x 65	1,60 \$
8103	2,5 µf	400 - 450 V	30 x 65	1,75 \$
8104	3,5 µf	400 - 450 V	30 x 65	1,85 \$

MOTOR İLK HAREKET (START) KONDANSATÖRLERİKONDANSATÖR
CAPACITOR

HAWCON Sipariş Kodu	EDE Sipariş Kodu	KAPASİTE	ÇAP (mm)	VOLT	Birim Fiyat AD. (\$)
8111	8131	36 - 43 µf	36	250V	2,40 \$
8112	8132	43 - 53 µf	36	250V	2,50 \$
8113	8133	47 - 56 µf	36	250V	2,65 \$
8114	8134	53 - 64 µf	36	250V	2,75 \$
8115	8135	64 - 77 µf	36	250V	2,90 \$
8116	8136	72 - 88 µf	36	250V	3,00 \$
8117	8137	88 - 108 µf	36 - 46	250V	3,15 \$
8118	8138	108 - 130 µf	36 - 46	250V	3,70 \$
8119	8139	124 - 149 µf	36 - 46	250V	3,85 \$
8120	8140	130 - 156 µf	36 - 46	250V	4,00 \$
8121	8141	145 - 175 µf	36 - 46	250V	4,30 \$
8122	8142	161 - 193 µf	46	250V	4,45 \$
8123	8143	189 - 227 µf	46	250V	4,60 \$
8124	8144	216 - 259 µf	46	250V	4,90 \$
8125	8145	233 - 280 µf	46	250V	5,75 \$
8126	8146	280 - 333 µf	46	250V	5,98 \$

**KONDANSATÖR GRUBU****MOTOR İLK HAREKET (START) KONDANSATÖRLERİ**

Sipariş Kodu	KAPASİTE	ÇAP (mm)	VOLT	Birim Fiyat AD. (\$)
8147	64 - 77 µf	36 x 86	330V	3,60 \$
8148	88 - 108 µf	36 x 86	330V	3,85 \$
8149	124 - 149 µf	36 x 86	330V	4,55 \$
8150	145 - 175 µf	36 x 86	330V	5,18 \$
8151	189 - 227 µf	46 x 86	330V	6,00 \$
8152	233 - 280 µf	46 x 86	330V	6,85 \$
8153	280 - 333 µf	46 x 86	330V	7,80 \$
8154	340 - 408 µf	52 x 86	330V	9,50 \$
8155	378 - 454 µf	52 x 110	330V	9,80 \$
8156	400 - 480 µf	52 x 110	330V	10,00 \$
8157	430 - 516 µf	52 x 110	330V	11,00 \$
8158	460 - 552 µf	52 x 110	330V	12,00 \$



KONDANSATÖR GRUBU (DAİMİ DEVRE MOTOR)

İTHALATIMIZ

FAN KONDANSATÖRLERİ KARE TİP



Kablolu Sipariş Kodu	Vidalı Sipariş Kodu	KAPASİTE / μf CBB 61	VOLT	Ölçü (mm) Ebatları	Birim Fiyat AD. (\$)
8171	8190	0,5 μf	400 - 450 V	36x11 x 22	0,75 \$
8172	8191	0,9 μf	400 - 450 V	36x11 x 22	0,76 \$
8173	8192	1 μf	400 - 450 V	36x11 x 22	0,80 \$
8174	8193	1,25 μf	400 - 450 V	36x11 x 22	0,83 \$
8209	8210	1,5 μf	400 - 450 V	38x13,5 x 24	0,87 \$
8175	8194	2 μf	400 - 450 V	38x15 x 25	0,90 \$
8176	8195	2,5 μf	400 - 450 V	38x15 x 25	0,95 \$
8177	8196	3 μf	400 - 450 V	38x15 x 25	1,03 \$
8178	8197	3,5 μf	400 - 450 V	38x15 x 25	1,15 \$
8179	8198	4 μf	400 - 450 V	47x17 x 28	1,20 \$
8180	8199	5 μf	400 - 450 V	47x20,5 x 33	1,35 \$
8181	8200	6 μf	400 - 450 V	47x 20,5 x 33	1,40 \$
8182	8201	7 μf	400 - 450 V	48 x 22 x 35	1,50 \$
8183	8202	8 μf	400 - 450 V	47 x 22 x 35	1,56 \$
8184	8203	10 μf	400 - 450 V	47 x 25 x 35	1,85 \$
8185	8204	12 μf	400 - 450 V	47 x 26 x 38	2,10 \$
8186	8205	15 μf	400 - 450 V	57 x 23 x 40	2,40 \$
8187	8206	16 μf	400 - 450 V	58 x 28 x 40	2,58 \$
8188	8207	20 μf	400 - 450 V	58 x 28 x 40	2,60 \$
8189	8208	25 μf	400 - 450 V	58 x 32 x 43	3,15 \$

ALÜMİNYUM TÜP, VIDALI, TERMİNALLI



HAWCON EDE Sipariş Kodu	KAPASİTE / μf CBB 65	VOLT	Ölçü (mm) Ebatları	Birim Fiyat AD. (\$)
8221	2 μf	400 - 450 V	40 x 70	1,45 \$
8222	3 μf	400 - 450 V	40 x 70	1,55 \$
8223	4 μf	400 - 450 V	40 x 70	1,70 \$
8224	5 μf	400 - 450 V	40 x 70	1,85 \$
8225	6 μf	400 - 450 V	40 x 70	1,95 \$
8226	8 μf	400 - 450 V	40 x 70	2,20 \$
8227	10 μf	400 - 450 V	40 x 70	2,50 \$
8242	12,5 μf	400 - 450 V	40 x 70	2,70 \$
8228	15 μf	400 - 450 V	40 x 60	3,25 \$
8229	20 μf	400 - 450 V	40 x 75	3,85 \$
8230	25 μf	400 - 450 V	45 x 75	4,15 \$
8231	30 μf	400 - 450 V	50 x 85	4,50 \$
8232	35 μf	400 - 450 V	50 x 100	5,50 \$
8233	40 μf	400 - 450 V	50 x 100	5,70 \$
8234	45 μf	400 - 450 V	50 x 110	6,40 \$
8235	50 μf	400 - 450 V	50 x 110	6,75 \$
8236	55 μf	400 - 450 V	50 x 110	7,70 \$
8237	60 μf	400 - 450 V	50 x 125	8,50 \$
8238	70 μf	400 - 450 V	50 x 125	11,00 \$
8239	80 μf	400 - 450 V	50 x 125	11,35 \$
8240	90 μf	400 - 450 V	50 x 125	12,90 \$
8241	100 μf	400 - 450 V	55 x 125	14,00 \$



ZnPP STANDART KUTU TİPİ 3 FAZ ALÇAK GERİLİM GÜÇ KONDANSATÖRLERİ



Sipariş Kodu	ÜRÜN KODU	GERİLİM	400 V	415 V	KAPASİTE (µf)	AD. / ₺
8301	ZG12D01B0	400 V, 50 Hz, Güç/kVAr	0.5	0.53	10	540,00 ₺
8302	ZG12D01D0		1.0	1.1	20	567,00 ₺
8303	ZG12D01G0		1.5	1.6	30	594,00 ₺
8304	ZG12D01K0		2.5	2.7	50	702,00 ₺
8305	ZG12D01S0		5.0	5.4	100	940,00 ₺
8306	ZG12D01V0		7.5	8.1	150	1.134,00 ₺
8307	ZG12D01X0		10.0	10.8	200	1.296,00 ₺
8308	ZG12D01Y0		12.5	13.5	250	1.458,00 ₺
8309	ZG12D0160		15.0	16.1	300	1.782,00 ₺
8310	ZG12D0180		20.0	21.5	400	2.268,00 ₺
8311	ZG12D0190		25.0	26.9	500	2.646,00 ₺
8312	ZG12D0A00		30.0	32.3	600	3.348,00 ₺
8313	ZG12D0280		40.0	43.0	800	4.806,00 ₺
8314	ZG12D0290		50.0	53.8	1000	5.562,00 ₺
8396	ZG12D02A0		60.0	64.6	1200	6.372,00 ₺

Sipariş Kodu	ÜRÜN KODU	GERİLİM	440 V	400 V	415 V	KAPASİTE (µf)	AD. / ₺
8315	ZJ12D01B0	440 V, 50 Hz, Güç/kVAr	0.5	0.4	0.4	8,22	540,00 ₺
8316	ZJ12D01D0		1.0	0.8	0.9	16,5	567,00 ₺
8317	ZJ12D01G0		1.5	1.2	1.3	25	594,00 ₺
8318	ZJ12D01K0		2.5	2.1	2.2	41	702,00 ₺
8319	ZJ12D01S0		5.0	4.1	4.4	82,5	940,00 ₺
8320	ZJ12D01V0		7.5	6.2	6.7	123,6	1.134,00 ₺
8321	ZJ12D01X0		10.0	8.3	8.9	164,7	1.296,00 ₺
8322	ZJ12D01Y0		12.5	10.0	11.1	206	1.458,00 ₺
8323	ZJ12D0160		15.0	12.5	13.3	247	1.782,00 ₺
8324	ZJ12D0180		20.0	16.5	17.8	330	2.268,00 ₺
8325	ZJ12D0190		25.0	20.0	22.2	411	2.646,00 ₺
8326	ZJ12D0A00		30.0	25.0	26.7	493,5	3.348,00 ₺
8327	ZJ12D0280		40	33.0	35.6	660	4.806,00 ₺
8328	ZJ12D0290		50	40.0	44.4	822	5.562,00 ₺
8397	ZJ12D02A0		60	50.0	53.7	987	6.372,00 ₺



Sipariş Kodu	ÜRÜN KODU	GERİLİM	525 V	440 V	480 V	KAPASİTE (µf)	AD. / ₺
8332	ZO12D01K0	525 V, 50 Hz, Güç/kVAr	2.5	1.8	2.1	29	702,00 ₺
8333	ZO12D01S0		5.0	3.5	4.2	58	940,00 ₺
8334	ZO12D01V0		7.5	5.3	6.2	87	1.134,00 ₺
8335	ZO12D01X0		10.0	7.0	8.3	116	1.296,00 ₺
8336	ZO12D01Y0		12.5	8.8	10.4	145	1.458,00 ₺
8337	ZO12D0160		15.0	10.5	12.5	173	1.782,00 ₺
8338	ZO12D0180		20.0	14.1	16.6	231	2.268,00 ₺
8339	ZO12D0190		25.0	17.5	20.8	289	2.646,00 ₺
8340	ZO12D0A00		30.0	21.1	25.0	348	3.348,00 ₺
8341	ZO12D0280		40.0	28.2	33.3	462	4.806,00 ₺
8342	ZO12D0290		50.0	35.0	41.7	578	5.562,00 ₺
8398	ZO12D02A0		60.0	42.2	50.0	696	6.372,00 ₺

Sipariş Kodu	ÜRÜN KODU	GERİLİM	690 V	690 V	KAPASİTE (µf)	AD. / ₺
8343	ZX12S01X0	690 V, 50 Hz, Güç/kVAr	10.0	10.0	66.9	1.960,00 ₺
8344	ZX12S01Y0		12.5	12.5	83.6	2.453,00 ₺
8345	ZX12S0180		20.0	20.0	133.8	3.864,00 ₺
8346	ZX12S0190		25.0	25.0	167.2	4.772,00 ₺

ZnPP STANDART KUTU TİPİ 1-2 (MONOFAZ - DİFAZ) ALÇAK GERİLİM GÜÇ KOND.

Sipariş Kodu	ÜRÜN KODU	GERİLİM	230 V	400 V	KAPASİTE (µf)	AD. / ₺
8347	Z412M01A0	230 V, 50 Hz, Güç/kVAr	0.25	0.75	15	471,00 ₺
8348	Z412M01B0		0.5	1.5	30	504,00 ₺
8349	Z412M01D0		1.0	3.0	60	560,00 ₺
8350	Z412M01G0		1.5	4.5	90	616,00 ₺
8351	Z412M01K0		2.5	7.5	150	751,00 ₺
8352	Z412M01S0		5.0	15.0	300	1.456,00 ₺
8353	Z412M01X0		10.0	30.0	600	2.744,00 ₺





GÜÇ KONDASATÖRLERİ

YETKİLİ BAYI

ZnPS SİLİNDİRİK TİP 3 FAZ ALÇAK GERİLİM GÜÇ KONDANSATÖRLERİ



Sipariş Kodu	ÜRÜN KODU	GERİLİM	400 V	415 V	KAPASİTE (µf)	AD. / ʘ
8354	YG12D01B0	400 V, 50 Hz, Güç/ kVAr	0.5	0.53	10	589,00 ʘ
8355	YG12D01D0		1.0	1.1	20	605,00 ʘ
8356	YG12D01G0		1.5	1.6	30	633,00 ʘ
8357	YG12D01K0		2.5	2.7	50	748,00 ʘ
8358	YG12D01S0		5.0	5.4	100	1.012,00 ʘ
8359	YG12D01V0		7.5	8.1	150	1.296,00 ʘ
8360	YG12D01X0		10.0	10.8	200	1.448,00 ʘ
8361	YG12D01Y0		12.5	13.5	250	1.674,00 ʘ
8362	YG12D0160		15.0	16.1	300	1.944,00 ʘ
8363	YG12D0180		20.0	21.5	400	2.430,00 ʘ
8364	YG12D0190		25.0	26.9	500	2.700,00 ʘ
8365	YG12D0A00	30.0	32.3	600	3.024,00 ʘ	

Sipariş Kodu	ÜRÜN KODU	GERİLİM	440 V	400 V	415 V	KAPASİTE (µf)	AD. / ʘ
8366	YJ12D01B0	440 V, 50 Hz, Güç/ kVAr	0.5	0.4	0.4	8,22	589,00 ʘ
8367	YJ12D01D0		1.0	0.8	0.9	16,5	605,00 ʘ
8368	YJ12D01G0		1.5	1.2	1.3	25	633,00 ʘ
8369	YJ12D01K0		2.5	2.1	2.2	41	748,00 ʘ
8370	YJ12D01S0		5.0	4.1	4.4	82,5	1.012,00 ʘ
8371	YJ12D01V0		7.5	6.2	6.7	123,6	1.296,00 ʘ
8372	YJ12D01X0		10.0	8.3	8.9	164,7	1.448,00 ʘ
8373	YJ12D01Y0		12.5	10.0	11.1	206	1.674,00 ʘ
8374	YJ12D0160		15.0	12.5	13.3	247	1.944,00 ʘ
8375	YJ12D0180		20.0	16.5	17.8	330	2.430,00 ʘ
8376	YJ12D0190		25.0	20.0	22.2	411	2.700,00 ʘ
8377	YJ12D0A00	30.0	25.0	26.7	493,5	3.024,00 ʘ	

Sipariş Kodu	ÜRÜN KODU	GERİLİM	480 V	440 V	2 FAZ 2 UÇLU	KAPASİTE (µf)	AD. / ʘ
	YY12D0170	480 V, 50 Hz, Güç/ kVAr	16,6	14,1		230	2.184,00 ʘ
	YY12D0H00		33,3	28,2		460	3.528,00 ʘ
	YY12P0H00		33,3	28,2	460	3.528,00 ʘ	



Sipariş Kodu	ÜRÜN KODU	GERİLİM	525 V	440 V	480 V	KAPASİTE (µf)	AD. / ʘ
8378	YO12D01K0	525 V, 50 Hz, Güç/ kVAr	2.5	1.8	2.1	29	748,00 ʘ
8379	YO12D01S0		5.0	3.5	4.2	58	1.012,00 ʘ
8380	YO12D01V0		7.5	5.3	6.2	87	1.296,00 ʘ
8381	YO12D01X0		10.0	7.0	8.3	116	1.448,00 ʘ
8382	YO12D01Y0		12.5	8.8	10.4	145	1.674,00 ʘ
8383	YO12D0160		15.0	10.5	12.5	173	1.944,00 ʘ
8384	YO12D0180		20.0	14.1	16.6	231	2.430,00 ʘ
8385	YO12D0190		25.0	17.5	20.8	289	2.700,00 ʘ
8386	YO12D0A00		30.0	21.1	25.0	348	3.024,00 ʘ
8387	YO12D0280		40.0	28.2	33.3	462	4.180,00 ʘ
8388	YO12D0290		50.0	35.0	41.7	578	5.170,00 ʘ

ZnPS SİLİNDİRİK TİP 1-2 (MONOFAZE - DİFAZE) ALÇAK GERİLİM GÜÇ KOND.



Sipariş Kodu	ÜRÜN KODU	GERİLİM	230 V	400 V	KAPASİTE (µf)	AD. / ʘ
8389	Y412M01A0	230 V, 50 Hz, Güç/ kVAr	0.25	0.75	15,1	600,00 ʘ
8390	Y412M01B0		0.5	1.5	30,1	644,00 ʘ
8391	Y412M01D0		1.0	3.0	60,2	840,00 ʘ
8392	Y412M01G0		1.5	4.5	90,3	1.008,00 ʘ
8393	Y412M01K0		2.5	7.5	150,5	1.288,00 ʘ
8394	Y412M01S0		5.0	15.0	301	1.960,00 ʘ
8395	Y412M01X0		10.0	30.0	602	3.080,00 ʘ

LEHİM TELLERİ VE HAVYA GRUBU

-duyar-
motorpompa®

Yenilikçi bina teknolojileri



CLASS

SOLOMON

ERTAN

Pro'sKit®

ER-SA Weller®

LEHİM TELLERİ





CİNSİ	MAKARA	FERAY Sipariş Kodu	FERAY Birim Fiyat	SOLDEX Sipariş Kodu	SOLDEX Birim Fiyat	KURTEL Sipariş Kodu	KURTEL Birim Fiyat
60 / 40 0,50 mm	500 gr	---	---	9051	68,00 \$	---	---
0,75 mm	500 gr	9001	2.290,00 ₺	9052	54,00 \$	9091	44,00 \$
0,80 mm	500 gr	9002	2.290,00 ₺	---	---	---	---
1,00 mm	500 gr	9003	2.280,00 ₺	9054	54,00 \$	9092	44,00 \$
1,20 mm	500 gr	9004	2.270,00 ₺	9055	54,00 \$	9093	44,00 \$
1,60 mm	500 gr	9005	2.269,00 ₺	9056	54,00 \$	9094	44,00 \$
2,00 mm	500 gr	9006	2.269,00 ₺	9057	54,00 \$	---	---
3,00 mm	500 gr	9007	2.269,00 ₺	9058	54,00 \$	---	---
4,00 mm	500 gr	9008	2.269,00 ₺	9059	54,00 \$	---	---
40 / 60 1,60 mm	500 gr	9009	1.650,00 ₺	9061	43,00 \$	9095	35,00 \$
30 / 70 1,60 mm	500 gr	9010	1.350,00 ₺	9062	35,00 \$	9096	30,00 \$
60 / 40 Arax	500 gr	9011	2.285,00 ₺	9060	55,00 \$	---	---
96 S Gümüş	500 gr	9017	8.800,00 ₺	---	---	---	---
60/40 Çubuk	Kg.	9018	4.150,00 ₺	---	---	---	---

CİNSİ	MAKARA	FERAY Sipariş Kodu	FERAY Birim Fiyat	SOLDEX Sipariş Kodu	SOLDEX Birim Fiyat	KURTEL Sipariş Kodu	KURTEL Birim Fiyat
60 / 40 0,50 mm	100 gr	---	---	9078	12,50 \$	---	---
0,75 mm	100 gr	---	---	9079	10,00 \$	---	---
1,00 mm	100 gr	---	---	9080	10,00 \$	---	---
1,20 mm	100 gr	---	---	9081	10,00 \$	---	---
60 / 40 0,50 mm	200 gr	---	---	9063	23,00 \$	---	---
0,75 mm	200 gr	9012	920,00 ₺	9064	17,00 \$	9097	19,00 \$
1,00 mm	200 gr	9013	920,00 ₺	9065	17,00 \$	9098	19,00 \$
1,20 mm	200 gr	9014	915,00 ₺	9066	17,00 \$	9099	19,00 \$
1,60 mm	200 gr	9015	915,00 ₺	9067	17,00 \$	9100	19,00 \$
40 / 60 1,60 mm	200 gr	9016	670,00 ₺	9068	14,00 \$	9115	15,00 \$
30 / 70 1,60 mm	200 gr	????	670,00 ₺	9069	11,00 \$	9116	13,00 \$
Tüp Lehim	25 gr	9024	320,00 ₺	9082	7,50 \$	9139	6,00 \$

KURŞUNSUZ LEHİM TELLERİ



CİNSİ	MAKARA	FERAY Sipariş Kodu	FERAY Birim Fiyat	SOLDEX Sipariş Kodu	SOLDEX Birim Fiyat
Sn 99,3, Cu 0,7 0,50 mm	500 gr	---	---	9071	102,00 \$
Sn 99,3, Cu 0,7 0,75 mm	500 gr	---	---	9072	78,00 \$
Sn 99,3, Cu 0,7 1,00 mm	500 gr	---	---	9073	78,00 \$
Sn 99,3, Cu 0,7 1,20 mm	500 gr	9019	3.350,00 ₺	9074	78,00 \$
Sn 99,3, Cu 0,7 1,60 mm	500 gr	---	---	9075	78,00 \$
Sn 99,3, Cu 0,7 0,50 mm	200 gr	---	---	9076	41,00 \$
Sn 99,3, Cu 0,7 1,20 mm	200 gr	---	---	9077	32,00 \$

LEHİM SUYU FLUX

Sipariş Kodu	CİNSİ	LİTRE	FERAY Birim Fiyat
9101	PC - 26	1 LT	210,00 ₺ / NET
9102	PC - 33	1 LT	221,00 ₺ / NET
9103	FSW - 32	1 LT	202,00 ₺ / NET
9104	ARAX FLUX	1 LT	150,00 ₺ / NET
9105	NO - CLEAN	1 LT	205,00 ₺ / NET
9106	ROL - 0	1 LT	205,00 ₺ / NET
9107	HİDRO - X	1 LT	185,00 ₺ / NET
9108	PC - 70 - TİNER	1 LT	165,00 ₺ / NET

Sipariş Kodu	CİNSİ	LİTRE	SOLDEX Birim Fiyat
9111	SR - 33	1 LT / Soldex	17,00 \$
9112	İZO PROPİL ALKOL	1 LT / Soldex	13,00 \$
9113	SRT - 33 TİNER	1 LT / Soldex	16,00 \$
9114	ARAX	1 LT / Soldex	12,00 \$

PURİNE - STANNOL - FELDER - HAWCON LEHİM PASTALARI

Sipariş Kodu	CİNSİ	GRAMAJ	Fiyat / Adet
9121	FELDER Lehim Pastası	50 Gr	3,00 €
9122	FELDER Lehim Pastası	100 Gr	7,00 €
9123	FELDER Lehim Pastası	250 Gr	10,50 €
9124	HAWCON Silikon Isı Transfer Pastası	40 Gr	2,70 \$
9125	HAWCON Silikon Isı Transfer Pastası	150 Gr	6,50 \$
9126	HAWCON Silikon Isı Transfer Pastası	250 Gr	10,00 \$
9127	HAWCON Silikon Isı Transfer Pastası	500 Gr	20,00 \$
9128	HAWCON Silikon Isı Transfer Pastası	1 Kg	38,00 \$
9129	HAWCON Lehim Pastası	50 Gr	2,00 \$
9130	HAWCON Lehim Pastası	100 Gr	3,80 \$
9131	HAWCON Lehim Pastası	250 Gr	8,20 \$
9132	FERAY Lehim Pastası	80 Gr	220,00 ₺
9133	Krem Lehim Enjektörde / SOLDEX	10 Gr	7,50 \$
9134	SOLDEX Lehim Pastası	50 Gr	4,00 \$
9135	SOLDEX Lehim Pastası	100 Gr	6,50 \$
9136	SOLDEX Lehim Pastası	250 Gr	14,00 \$
9137	KALIP NİŞADIR (Havya ucu temizleme)	250 Gr	9,50 \$
9138	CURUF AYRIŞTIRICI (Potalar için)	250 Gr	15,00 \$

Weller® LEHİM TABANCIKLAR VE KALEM HAVYALAR

WLG940023C Lehim Tabancası



KOD: WLG940023C

- 480°C kullanım sıcaklığı
- 140 Watt,
- 230 Volt,
- 50 Hz

Sipariş Kodu: 9141

80,60 € / Adet

WLG9400K23C Lehim Tabancası



KOD: WLG9400K23C

- 480°C kullanım sıcaklığı
- 140 Watt,
- 230 Volt,
- 50 Hz

Standart Ekipmanlar

Konik uç, kesme ucu, düz uç, altıgen anahtar, lehim makarası

Sipariş Kodu: 9142

96,80 € / Adet

Lehim Pompası



KOD: SA-21A

Sipariş Kodu	Açıklama	AD. / €
9190	Lehim Pompası (Metal Gövde)	43,00 €

Havya Aksesuarları

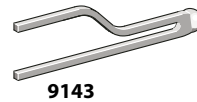

9143

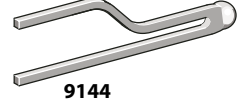

9144

Sip. Kodu	Kod	Kul. Lehim Tab.	Açıklama	AD. / €
9143	7135	8100 - 9200	Bakır Havya Ucu (2 Adet)	7,90 €
9144	7250	05C	Demir K.Havya Ucu (1 Ad.)	17,40 €

SL Serisi Kalem Havyalar



SL-120

KOD	WATT	VOLT	HZ	UÇ	⚖️	AD. / €
9145	120	230	50	12,5 mm	930 gr	100,50 €
9146	175	230	50	16 mm	1030 gr	121,70 €
9147	200	230	50	20 mm	1190 gr	148,80 €

SL Serisi Kalem Havyalar



9150

9151

9149

9148

Sip. Kodu	Kod	UYUMLU	ŞEKİL	ÇAP / UÇ	AD. / €
9148	S-7	SL100-120	Eğik	12,5 mm	29,20 €
9149	S-41	SL120	Eğik	12,5 mm	33,12 €
9150	43111	SL175	Eğik	16,0 mm	31,93 €
9151	43112	SL251	Eğik	20,0 mm	49,80 €

WLSK3023C / 30W Lehimleme İstasyonu



KOD: WLSK3023C

- Azami sıcaklık 400 °C
- Güç Tüketimi 30W
- Şebeke gerilimi 230 V / 50Hz

* WLIR3023C yedek uçları ile uyumludur.

Sipariş Kodu: 9154

116,60 € / Adet

WLSK8023C / 80W Lehimleme İstasyonu



KOD: WLSK8023C

- Azami sıcaklık 485 °C
- Güç Tüketimi 80W
- Şebeke gerilimi 230 V / 50Hz

* WLIR8023C yedek uçları ile uyumludur.

Sipariş Kodu: 9155

136,50 € / Adet

SPI Serisi Kalem Havyalar



W-101

W-61

W-201

Sipariş Kodu	Açıklama	AD. / €
9185	W-61 60W Termikli Kalem Havya	174,00 €
9186	W-101 100W Termikli Kalem Havya	195,00 €
9187	W-201 200W Termikli Kalem Havya	249,00 €

SPI Serisi Kalem Havyalar



15-25-40 W

80 W

Sipariş Kodu	Açıklama	AD. / €
9180	SPI-16 15W Kalem Havya	102,00 €
9181	SPI-27 25W Kalem Havya	102,00 €
9182	SPI-41 40W Kalem Havya	102,00 €
9183	SPI-81 75W Kalem Havya	117,00 €

Weller® KALEM HAVYALAR VE İSTASYON HAVYALARI

WLIR3023C / 30W LED'li Kalem Havya Seti



- KOD: WLIR3023C**
- 400°C kullanım sıcaklığı,
 - 30 Watt
 - 230 Volt, 50 Hz
 - Uç tipi model Serisi 4 mm (5/16")

Sipariş Kodu: 9152

46,80 € / Adet

WLIR3023C UYUMLU HAVYA UÇLARI

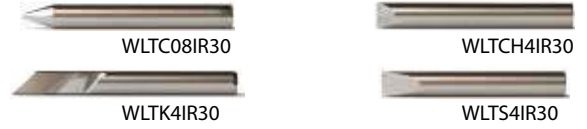

Sip. Kodu	KOD	AÇIKLAMA	AD. / €
9157	WLTK4IR30	Bıçak Havya Ucu 4 mm 3'lü	11,10 €
9158	WLTC08IR30	Konik Havya Ucu 0.8 mm 3'lü	16,64 €
9159	WLTC4IR30	Keski Havya Ucu 4 mm 3'lü	11,10 €
9160	WLTS4IR30	Keski Havya Ucu 4 mm 3'lü	11,10 €

WLIR6023C / 60W LED'li Kalem Havya Seti



- KOD: WLIR6023C**
- 425°C kullanım sıcaklığı,
 - 60 Watt
 - 230 Volt, 50 Hz
 - Uç Tipi model Serisi 6 mm (1/4")

Sipariş Kodu: 9161

53,30 € / Adet

WLIR6023C UYUMLU HAVYA UÇLARI



Sip. Kodu	KOD	AÇIKLAMA	AD. / €
9162	WLTC08IR60	Konik Havya Ucu 0,8 mm 3'lü	17,55 €
9163	WLTC04IR60	Konik Havya Ucu 0,4 mm 3'lü	17,55 €
9164	WLTC6IR60	Keski Havya Ucu 6,4 mm 3'lü	13,00 €
9165	WLTS24IR60	Keski Havya Ucu 2,4 mm 3'lü	13,00 €

WLIR8023C / 80W LED'li Kalem Havya Seti



- KOD: WLIR8023C**
- Azami sıcaklık 485 °C
 - Güç Tüketimi 80W
 - Şebeke gerilimi 230 V / 50Hz
 - Uç Tipi model Serisi 10 mm (3/8")

Sipariş Kodu: 9166

61,10 € / Adet

WLIR8023C UYUMLU HAVYA UÇLARI

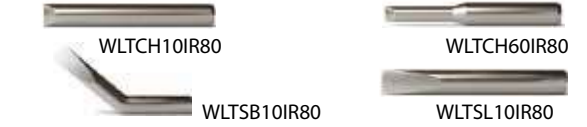

Sip. Kodu	KOD	AÇIKLAMA	AD. / €
9167	WLTC10IR80	Keski Havya Ucu 10 mm 3'lü	22,17 €
9168	WLTC60IR80	Keski Havya Ucu 6,4 mm 3'lü	22,17 €
9169	WLTSB10IR80	Eğri Keski Havya Ucu 10 mm 3'lü	29,40 €
9170	WLTS10IR80	Keski Havya Ucu 10 mm 3'lü	29,40 €

WLIRK3023C / 30W LED'li Kalem Havya Seti



- KOD: WLIRK3023C**
- 400°C kullanım sıcaklığı,
 - 30 Watt
 - 230 Volt, 50 Hz
 - 0.8 mm
- Standart Ekipmanlar**
WLIR3023C Havya,
Keski Havya Ucu 4 mm,
Konik Havya Ucu 0.8 mm,
Lehim Makarası

Sipariş Kodu: 9156

50,30 € / Adet

WPS 18MPEU / LED'li Yüksek Performanslı Havya



- KOD: WPS 18MPEU**
- 480°C kullanım sıcaklığı
 - 35 saniyede ısınmaktadır
 - 0.8mm havya ucu
 - 18 Watt,
 - 9V, DC

Sipariş Kodu: 9193

70,10 € / Adet

WLIRK6023C / 60W LED'li Kalem Havya Seti



- KOD: WLIRK6023C**
- 425°C kullanım sıcaklığı,
 - 60 Watt
 - 230 Volt, 50 Hz
 - 6.4 mm
- Standart Ekipmanlar**
WLIR6023C Havya,
Keski Havya Ucu 2.4 / 6.4 mm,
Konik Havya Ucu 0.8 mm,
Lehim Makarası

Sipariş Kodu: 9153

63,70 € / Adet

WLIBA4/ 4.5W Akülü Havya



- KOD: WLIBA4**
- Güç Tüketimi: 4,5 W
 - Akü : 4,5 V

Sip.Kod: 9175

38,87 € / Ad.



- KOD: WLTC03IBA4**
Konik Havya Ucu 0,3 mm 3'lü

Sip.Kod: 9176

26,00 € / Ad.

CLASS HAVYA GRUBU

ZD-200 C Kalem Havya



- Güçlü mika rezistans
- Hafif ve Ergonomik
- Uçtan somunlu tasarım
- Topraklı elektrik kablosu
- Blister paketli

Sip. Kodu	Ürün No	Güç	Fiyatı / \$
9201	ZD 200C - 30	30 W	7,50 \$
9202	ZD 200C - 40	40 W	7,50 \$
9203	ZD 200C - 60	60 W	10,50 \$

ZD-200 C Kalem Havya Uçları



Sip. Kodu	Ürün No	Fiyatı / \$
9204	C1-1	1,60 \$
9205	C1-2	1,60 \$

ZD-407 Kalem Havya



- Güçlü mika rezistans
- Hafif ve Ergonomik
- Uçtan vidalı tasarım
- Topraklı elektrik kablosu
- Blister paketli

Sip. Kodu	Ürün No	Güç	Fiyatı / \$
9206	ZD 407C - 30	30 W	7,50 \$
9207	ZD 407C - 40	40 W	7,50 \$
9208	ZD 407C - 60	60 W	10,50 \$

ZD-407 Kalem Havya Uçları

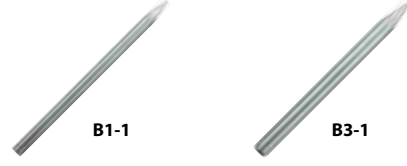

Sip. Kodu	Ürün No	Fiyatı / \$
9209	B1-1	1,60 \$
9210	B3-1	2,60 \$

ZD-401 Kalem Havya



- Güçlü mika rezistans
- Hafif ve Ergonomik
- Uçtan vidalı tasarım
- Topraklı elektrik kablosu
- Blister paketli

Sip. Kodu	Ürün No	Güç	Fiyatı / \$
9211	ZD 401C - 80	80 W	11,00 \$
9212	ZD 401C - 100	100 W	12,50 \$

ZD-401 Kalem Havya Uçları

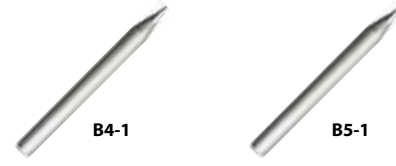

Sip. Kodu	Ürün No	Fiyatı / \$
9213	B4-1	3,30 \$
9214	B5-1	4,30 \$

ZD-715L Yüksek Güçlü Havya



- Açma / kapama anahtarlı
- Güçlü mika rezistans
- İzoleli tutacak yeri
- Hafif ve Ergonomik
- Uçtan vidalı tasarım
- Topraklı elektrik kablosu
- Metal Stand
- Blister paketli

Sip. Kodu	Ürün No	Güç	Fiyatı / \$
9215	ZD 715L - 150	150 W	28,00 \$
9216	ZD 715L - 200	200 W	34,00 \$
9217	ZD 715L - 300	300 W	43,00 \$

ZD-715L 150W Havya Uçu



Sip. Kodu	Ürün No	Fiyatı / \$
9218	Y3-1	14,00 \$

JCD-908S 80W Isı Ayarlı Havya



Sip. Kodu	Ürün No	Güç	Fiyatı / \$
9219	JCD-908S	80 W	25,00 \$

ZD-99 Lehimleme İstasyonu



KOD: ZD-99

Kalem Havya
Güç : 48 Watt
Isı Aralığı : 200°C - 480°C

Sipariş Kodu: 9220

37,00 \$ / Adet

Yihua 936B Havya ve Lehimleme İstasyonu



- Bükülmeyecek ve daha uzun ömürlü olmayacak yüksek kaliteli seramik ısıtıcıyı uygular.
- Anti-statik tasarım, hassas bileşenlerin hasar görmesini etkili bir şekilde önler.

Güç : 40 Watt
Isı Aralığı : 200°C - 480°C
Sıcaklık Kararlılığı : ±10 °C (statik)

Sipariş Kodu: 9221

50,00 \$ / Adet

Yihua 937D Havya ve Lehimleme İstasyonu



- Dijital Ekran
- Bükülmeyecek ve daha uzun ömürlü olmayacak yüksek kaliteli seramik ısıtıcıyı uygular.
- Anti-statik tasarım, hassas bileşenlerin hasar görmesini etkili bir şekilde önler.

Güç : 40 Watt
Isı Aralığı : 200°C - 480°C
Sıcaklık Kararlılığı : ±10 °C (statik)

Sipariş Kodu: 9222

56,00 \$ / Adet

Yihua 852D+ Diyafram Isı Ayarlı Sıcak Hava Üfleme Havya



Makine gücü: 600W ± 10% (MAX)
Çalışma ortamı: 0°C ~ 40 °C bağıl nem < %80
Depolama sıcaklığı: -20 ~ 80 °C bağıl nem < %80

Sıcak Hava Tabancası / Lehimleme

Çıkış gücü: 550W / 60W
Sıcaklık aralığı: 100°C ~ 500 °C / 100°C ~ 500°C
Hava akışı modu: Brushless Koldan üfleme / -
Hava akımı: 24-28L / dakika (maks) /
Sıcaklık kararlılığı: ± 15 °C (statik) / ± 10 °C (statik)
Isıtıcı: Isıtmalı çekirden seramik ısıtıcı / Ortak ısıtıcı

Sipariş Kodu: 9223

108,00 \$ / Adet

Yihua 878D Havya ve Lehimleme İstasyonu



Kalem Havya
Güç : 60 Watt
Isı Aralığı : 200°C - 480°C

Sıcak Hava Üfleme
Güç : 740 Watt
Isı Aralığı : 100°C - 480°C

Sipariş Kodu: 9224

90,00 \$ / Adet

936 A Lehimleme İstasyonu



- Analog
 - Kolay ısı ayarı
 - Yüksek hassasiyet
 - Güçlü seramik rezistans
- Kalem Havya
Güç : 60 Watt
Isı Aralığı : 200°C - 480°C
Çıkış Voltajı: 24V AC

Sipariş Kodu: 9225

58,00 \$ / Adet

968D Lehimleme ve Sıcak Hava İstasyonu



- Kolay ısı ayarı
- Brushless Fan (Koldan fanlı)
- Otomatik uyku fonksiyonu

Kalem Havya
Güç : 60 Watt
Isı Aralığı : 200°C - 480°C

Sıcak Hava Üfleme
Güç : 500 Watt
Isı Aralığı : 100°C - 500°C

Sipariş Kodu: 9226

112,00 \$ / Adet

ZD-192 Lehim Pompası



Metal

Sip. Kodu: 9227 5,00 \$ / Adet

ZD-10 A Havya Sehpa



Sip. Kodu: 9228 4,00 \$ / Adet

938 A Lehimleme İstasyonu



- Dijital LED ekran
- Kolay ısı ayarı
- Yüksek hassasiyet
- Güçlü seramik rezistans

Kalem Havya
Güç : 60 Watt
Isı Aralığı : 200°C - 480°C
Çıkış Voltajı: 24V AC

Sipariş Kodu: 9229

68,00 \$ / Adet

ZD-11 W Lehim Temiz. Teli



Altıklı

Sip. Kodu: 9230 6,50 \$ / Adet

ZD-12 W Lehim Temiz. Teli



Sip. Kodu: 9231 4,50 \$ / Adet

Lehim Alma Teli



ZD-180

Sip. Kodu	Genişlik	Fiyatı / \$
9232	1,00 mm	1,80 \$
9233	1,50 mm	2,00 \$
9234	2,00 mm	2,25 \$
9235	3,00 mm	3,00 \$

SOLOMON SET VE KALEM HAVYALAR

SR965 - 40W Kalem Havya

SOLOMON



Sip. Kodu: 9236 \$ / Adet

SR968 - 30W Kalem Havya

SOLOMON



Sip. Kodu: 9237 \$ / Adet

SL-20/30 Yedek Havya

SOLOMON



Sip. Kodu: 9238 \$ / Adet

SH-817 Metal Gövdeli Lehim Pompası

SOLOMON



Sip. Kodu: 9239 \$ / Adet

SL30 Dijital Isı Ayarlı Havya 24V/48W

SOLOMON



Sip. Kodu: 9240 \$ / Adet

Havya Uçları (G1-G2) (621-623)

SOLOMON



SL 20/30 Havya Ucu 965-968 Havya Ucu

Sip. Kodu	Kod	Fiyatı / \$
9241	SL 20/30	- \$
9242	965/968	- \$

SS-306 Analog Isı Ayarlı Havya

Pro'sKit® 60 W / 480 °C



Sip. Kodu: 9243 90,00 \$ / Adet

HS-15 Havya Temizleme Süngeri



Sip. Kodu: 9244 1,10 \$ / Adet

236 ESD İstasyonlu Havya

UICK®



90W, ESD Gövde

Sip. Kodu: 9245 150,00 \$ / Adet

SONAR TABANCA HAVYALAR

HS-01 100W Sonar Tabanca Havya



Sip. Kodu: 9246 57,00 \$ / Adet

HS-03 100W Sonar Tabanca Havya Ucu



Sip. Kodu: 9247 4,25 \$ / Adet

HS-02 250W Sonar Tabanca Havya



Sip. Kodu: 9248 165,00 \$ / Adet

ÖLÇÜ ALETLERİ

-duyar-
motorpompa®

Yenilikçi bina teknolojileri

UNI-T®



UNI-T® ÖLÇÜ ALETLERİ



MODEL	FİYAT / \$
UT07B-EU	18,00 \$
A12T	22,00 \$
A25M	140,00 \$
A37	205,00 \$
A61	24,00 \$
UT12D	11,00 \$
UT12E	21,00 \$
UT12M	24,00 \$
UT15C	64,00 \$
UT18D	94,00 \$
UT22B-EU	22,00 \$
UT17B PRO	160,00 \$
UT33A+	30,00 \$
UT33B+	20,00 \$
UT33C+	23,00 \$
UT33D+	21,00 \$
UT39A+	36,00 \$
UT39C+	46,00 \$
UT39E	64,00 \$
UT58D	72,00 \$
UT58A	60,00 \$
UT58C	70,00 \$
UT58E	121,00 \$
UT61B+	110,00 \$
UT61C	81,00 \$
UT61D+	120,00 \$
UT61E+	190,00 \$
UT71A	270,00 \$
UT71B	330,00 \$
UT71C	380,00 \$
UT71D	460,00 \$
UT71E	520,00 \$
UT81C	550,00 \$
UT89X	50,00 \$
UT89XD	56,00 \$
UT89XE	103,00 \$
UT107	60,00 \$
UT116C	40,00 \$
UT118B	60,00 \$

MODEL	FİYAT / \$
UT120A	31,00 \$
UT120C	38,00 \$
UT123	24,00 \$
UT123D	40,00 \$
UT125C	40,00 \$
UT136C+	46,00 \$
UT139C	96,00 \$
UT151C	62,00 \$
UT171A	345,00 \$
UT171B	500,00 \$
UT181A	700,00 \$
UT191E	117,00 \$
UT191T	150,00 \$
UT195M	250,00 \$
UT195DS	300,00 \$
UT200A	36,00 \$
UT201+	42,00 \$
UT202+	48,00 \$
UT202A+	44,00 \$
UT203+	84,00 \$
UT204+	94,00 \$
UT205E	92,00 \$
UT206B	120,00 \$
UT208B	200,00 \$
UT210D	110,00 \$
UT210E	110,00 \$
UT211B	220,00 \$
UT216C	180,00 \$
UT216D	260,00 \$
UT219E	180,00 \$
UT219DS	270,00 \$
UT220	120,00 \$
UT221	200,00 \$
UT222	400,00 \$
UT230B-EU	44,00 \$
UT243	600,00 \$
UT251C	250,00 \$

MODEL	FİYAT / \$
UT253A	760,00 \$
UT256B	140,00 \$
UT261A	90,00 \$
UT265B	790,00 \$
UT267B	1.400,00 \$
UT276A+	630,00 \$
UT278A+	750,00 \$
UT281C	190,00 \$
UT281E	250,00 \$
UT300A+	28,00 \$
UT300S	28,00 \$
UT300R	26,00 \$
UT301C+	104,00 \$
UT302C+	130,00 \$
UT303C+	220,00 \$
UT305S	360,00 \$
UT305R	33,00 \$
UT306A	34,00 \$
UT306C	28,00 \$
UT309A	120,00 \$
UT309E	148,00 \$
UT315A	700,00 \$
UT320D	34,00 \$
UT321	140,00 \$
UT322	160,00 \$
UT325	170,00 \$
UT330THC	80,00 \$
UT330T	48,00 \$
UT330TH	70,00 \$
UT331+	86,00 \$
UT332+	120,00 \$
UT333	36,00 \$
UT333BT	42,00 \$
UT333S	44,00 \$
UT337A	130,00 \$
UT343A	150,00 \$
UT343E	300,00 \$
UT334A	130,00 \$



UNI-T® ÖLÇÜ ALETLERİ



MODEL	FİYAT / \$
UT343D	180,00 \$
UT352	250,00 \$
UT353	34,00 \$
UT353BT	46,00 \$
UT362	310,00 \$
UT363	34,00 \$
UT363BT	42,00 \$
UT363S	64,00 \$
UT372	150,00 \$
UT373	40,00 \$
UT377A	40,00 \$
UT381A	110,00 \$
UT383	34,00 \$
UT383BT	44,00 \$
UT383S	52,00 \$
UT385	290,00 \$
UT387A	60,00 \$
LM40T	68,00 \$
LM50A	43,00 \$
LM60T	74,00 \$
LM70A	60,00 \$
LM100A	81,00 \$
LM120A	110,00 \$
LM320A	56,00 \$
LM570R-I	80,00 \$
UT501A	124,00 \$
UT502A	220,00 \$
UT505B	540,00 \$
UT511	240,00 \$
UT513A	650,00 \$
UT516B	2.600,00 \$
UT521	312,00 \$
UT522	344,00 \$
UT526	370,00 \$

MODEL	FİYAT / \$
UT533	400,00 \$
UT582+	220,00 \$
UT603	88,00 \$
UT612	280,00 \$
UT620A	870,00 \$
UT658	16,00 \$
UT658A	18,00 \$
UT658B	13,00 \$
UT658DUAL	26,00 \$
UT658LOAD	40,00 \$
UT665	150,00 \$
UT681C	26,00 \$
UT681HDMI	38,00 \$
UT682	64,00 \$
UT682D	36,00 \$
UT691-01	35,00 \$
UT691-10	50,00 \$
UT692G	70,00 \$
UT693D	110,00 \$
UT701	410,00 \$
UT705	520,00 \$
UT714	1.260,00 \$
UT715	1.260,00 \$
UT801	220,00 \$
UT8802E	360,00 \$
UT8803E	460,00 \$
UT8804E	740,00 \$
UT8805E	1.380,00 \$
UTi165A	820,00 \$
UTi165K	900,00 \$
UTi220K	930,00 \$
UTi165A+	840,00 \$
UTD1025CL	850,00 \$
UTD1025DL	1.050,00 \$

MODEL	FİYAT / \$
UTD1050CL	840,00 \$
UTD1050DL	1.150,00 \$
UTD1102C	1.500,00 \$
UTD1202C	2.300,00 \$
UTD2052CL	640,00 \$
UTD2102CEX	720,00 \$
UPO3154E	3.200,00 \$
UPO3252E	2.800,00 \$
UTP1306	290,00 \$
UTG1010A	500,00 \$
UTG2025A	920,00 \$
UTG2122B	1.400,00 \$
UT-L17	10,00 \$
UT-L21	6,00 \$
UT-L20	5,20 \$
UT-L27	11,00 \$
UT-L35	84,00 \$
UT-T04	52,00 \$
UT-T07	52,00 \$
UT-H05	38,00 \$
UT-P04	28,00 \$
UT-P05	36,00 \$
UT-C02B	16,00 \$
UT-C01	20,00 \$
UT-CS09C	115,00 \$
UT-CS09D	128,00 \$
LM40Mi	54,00 \$
LM60Mi	60,00 \$
UT-362H	320,00 \$
UT-T10K	10,00 \$
UT-T07	52,00 \$
UT-T04	52,00 \$
UT-L90	17,00 \$
UT-L27	11,00 \$

ÖLÇÜ ALETLERİ

MS-6812 KABLO TAKİP CİHAZI



Sipariş Kodu
9611

Fiyatı (\$) **23,00 \$**

Ton frekansı : 1.5KHz
Frekans Aralığı : 100Hz-300KHz
Batarya : 2 x 9V 6F22

TES 3014 PENSAMPERMETRE



Sipariş Kodu
9612

Fiyatı (\$) **75,00 \$**

Kategori: CAT II 1000V, CAT III 600V
Kapasitans ölçümü 2000µF.
Değişken frekanslı sürücü VFD gerilimi ve Akım ölçümü.
ACA: 600A (3013), 1000A (3014)

M-266 PENSAMPERMETRE



Sipariş Kodu
9613

Fiyatı (\$) **16,00 \$**

Ac Akım : 20-200-1000A ± %3.0
Ac Voltaj : 20-200-750V(600V) ± %1.0
Dc Voltaj : 200M-2-20-200-1000V ± %0.8
İzolasyon : 20m-2000mΩ±%2.0~4.0
OHM : 200-20k-2MΩ ± %1.0

VC-850 3 FAZ SIRASI TEST ALETİ



Sipariş Kodu
9614

Fiyatı (\$) **55,00 \$**

Yüksek güvenilirlik
200VAC' den 600VAC'ye kadar geniş bir 3 faz güç kaynağı yelpazesini test edebilir.

6890-63 62DC / 16-380V FAZ KONTROL KALEMİ



Sipariş Kodu
9615

Fiyatı (\$) **7,00 \$**

62DC Genel Amaçlı Voltaj tester
16V-380V arası

6885-48 M VOLTAJ TEST KALEMİ



Sipariş Kodu
9616

Fiyatı (\$) **4,60 \$**

DC Voltaj : Temaslı 70-250 V
AC Voltaj : Temasız 70 – 10.000 V
Polarite Kontrolü : 1.2 VDC - 36 VDC
Süreklilik Testi 0=5 MΩ, L=0-50 MΩ, H=0-100 MΩ
Led ve Sesli İkaz : Var Mikro Dalga Kontrolü : Var

6878-28 DCY 25 DİJİTAL KONTROL KALEMİ



Sipariş Kodu
9617

Fiyatı (\$) **2,15 \$**

12-500 V aralığından AC-DC Voltaj ölçümüyle toprak ve AC kablo kopukluklarını tespit eder. Voltaj bölünmeli dijital ekran.

MAS 830 L DİJİTAL MULTİMETRE



Sipariş Kodu
9618

Fiyatı (\$) **15,00 \$**

Direnç : 200Ω - 2KΩ - 20KΩ - 200KΩ - 2MΩ (± % 1.0)
Diyot : 3.0 V / 0.8 mA
Sesli ikaz : EVET
Ağırlık : 170 g
DC Voltaj : 200mV / 2V / 20V / 200V / 600V (± %0.8)
AC Voltaj : 200V - 600V (± %1.5)

M 832 DİJİTAL MULTİMETRE



Sipariş Kodu
9619

Fiyatı (\$) **7,50 \$**

DC Voltaj : 200M-2-20-200-1000V ± %0.5
AC Voltaj : 200-750V ± %1
DC Akım : 2m 20m 200m-10A± %1.3
OHM : 200-2k-20k-200k-2MΩ±%0.8
DİOT Test : 3.0V/0.8mA
Transistor : hfe0~1000
Sesli ikaz : Var
Sinyal çıkışı : 50Hz Kare dalga
Ağırlık:170g, Batarya:6F22,9Vx1

ÖLÇÜ ALETİ PROPLARI



Sipariş Kodu
9620

T-61 Silikon Prop
Fiyatı (\$) 100cm

12,00 \$



Sipariş Kodu
9621

T-91 Prop
Fiyatı (\$) 100cm

3,20 \$



Sipariş Kodu
9622

T-81 Osiloskop Probu
Fiyatı (\$) 103 cm

25,00 \$

KS 268 ANALOG ÖLÇÜ ALETLERİ



Sipariş Kodu
9623

Fiyatı (\$) **32,00 \$**

Ekran : İbrelili, Analı skala
DC Voltaj Kademe : 0.3V, 3V, 12V, 30V, 120V, 300V, 1200V
Tanım : Analog ölçü aleti
DC Voltaj : 1200V
AC Voltaj Kademe : 50V, 120V, 300V, 1200V
Direnç : 1000 mΩ
DC Akım Kademe : 3mA, 30mA, 300mA, 12A
Diod Testi, Transistor Testi, DC Akım : 12 Amper

İZELTAŞ KONTROL KALEMİ



Sipariş Kodu
9624

KP 3458
Fiyatı (₺) 190 mm
201,25 ₺



Sipariş Kodu
9625

KP 3459
Fiyatı (₺) 135 mm
157,50 ₺

BANT, SPREY VE SICAK HAVA TABANICALARI

-duyar-
motorpompa®

Yenilikçi bina teknolojileri



Coroplast



KSN® ERIYEN BANTLAR

İTHALATIMIZ



Esnek yapısı sayesinde kullanımı rahat olup, kabloların ek yerlerine yapıştırdıktan kısa bir süre sonra kendiliğinden eriyerek sızdırmazlık sağlamaktadır.

Sipariş Kodu	ÜRÜN KODU	AÇIKLAMA	KOLİ ADEDİ	FİYAT (\$)
9671	BANT 006	19 mm x 0.8 mm x 8 mt Eriyen Bant	60	2,00 \$
9672	BANT 007	50 mm x 0.8 mm x 8 mt Eriyen Bant	24	5,00 \$

GLOBE İZOLE BANTLAR



Sipariş Kodu	ÜRÜN KODU	AÇIKLAMA	KOLİ AD.	FİYAT
9673	GLOBE SİYAH VE RENKLİ	19 mm x 9,1 mt	500	
9674	GLOBE SARI / YEŞİL	19 mm x 9,1 mt	500	
9675	GLOBE KAHVERENGİ	19 mm x 9,1 mt	500	
9676	GLOBE SİYAH	50 mm x 25 mt	60	

ÇİFT TARAFLI BANTLAR



Sipariş Kodu	ÜRÜN KODU	CİNSİ	ÖLÇÜ (mm)	BİRİM FİYAT ADET (₺)
9677	ÇTBANT-155	Çift Taraflı Bant	10 mm x 10 mt	35,00 ₺
9678	ÇTBANT-156	Çift Taraflı Bant	12 mm x 10 mt	40,00 ₺
9679	ÇTBANT-157	Çift Taraflı Bant	19 mm x 10 mt	60,00 ₺
9680	ÇTBANT-158	Çift Taraflı Bant	19 mm x 25 mt	155,00 ₺
9681	ÇTBANT-159	Çift Taraflı Bant	25 mm x 10 mt	80,00 ₺
9682	ÇTBANT-160	Çift Taraflı Bant	30 mm x 10 mt	96,00 ₺
9683	ÇTBANT-162	Çift Taraflı Bant	38 mm x 10 mt	120,00 ₺
9684	ÇTBANT-163	Çift Taraflı Bant	50 mm x 10 mt	160,00 ₺
9685	ÇTBANT-164	Yapışkanlı Alü. Bant	50 mm x 30 mt	4,00 \$

Coroplast TÜYLÜ ve TÜYSÜZ BEZ BANTLAR



Sipariş Kodu	ÜRÜN KODU	CİNSİ	ÖLÇÜ (mm)	BİRİM FİYAT ADET (€)
9686	TBBANT-151	Tüysüz Bant	9 mm x 15 mt	1,30 €
9687	TBBANT-152	Tüysüz Bant	19 mm x 15 mt	1,50 €
9688	TBBANT-153	Tüysüz Bant	19 mm x 25 mt	2,45 €
9689	TBBANT-154	Tüylü Bant	19 mm x 15 mt	1,50 €
9690	TBBANT-155	Tüysüz Bant	50 mm x 25 mt	7,60 €
9691	TBBANT-156	Beyaz Bez Bant (Yerli)	19 mm x 25 mt	135,00 ₺
9692	TBBANT-157	Beyaz Bez Bant (Yerli)	25 mm x 25 mt	185,00 ₺

TEFLON BANTLAR



Sipariş Kodu	ÜRÜN KODU	CİNSİ	ÖLÇÜ (mm)	BİRİM FİYAT ADET
9693	RESİFLON	Teflon Bant Resiflon	12 x 0,076 x 12	0,48 €
9694	CARTEL	Teflon Bant Resiflon	12 x 0,076 x 12	0,32 \$

SICAK HAVA TABANÇALARI

CAT Sıcak Hava Tabancası

CAT-202
Güç : 2000 W
Isı : 350 - 550 °C
Devir : 300-500 l/dak

Sip. Kodu: 9751

32,00 \$ / Adet

STEINEL HL 1620 S - 1600 WATT

STEINEL

HL 1620 S
Güç : 1600 W
Isı : 300 - 500 °C
Hava : 240-450 lt/dk.
Kablo : 2,2 mt
Ebat : 252x85,5x200 mm
Ağırlık : 670 gr

Sip. Kodu: 9752

55,00 € / Adet



SİLİKON TABANÇALARI ve MUM SİLİKONLAR

Silikon Tabancası - 55 W

YAPİSTİRİCİ TABANÇASI
Quick Easy Versatile
Hızlı Kolay Pratik

Sip. Kod: 9753

13,00 \$ / Adet

Silikon Tabancası - 80 W

GLUE GUN
Professional

Sip. Kod: 9754

28,00 \$ / Adet

Silikon Tabancası - 100 W

GLUE GUN
Heavy Duty Industrial

Sip. Kod: 9755

53,00 \$ / Adet

Mum Silikon, 8 - 11 mm

9756 / Şeffaf 11,00 \$ / Kg
9757 / Siyah 14,00 \$ / Kg

HAWCON® SPREY ÇEŞİTLERİ

İMALATIMIZ



HAWCON®



HW 01 - Yağsız Kontak Spreyi
Degreaser Cleaner

200 ml.

Kirli ve yıpranabilir yüzeyler, elektronik bağlantıları, fişler, voltaj regülatörleri, akım düzenleyiciler, telefon aksamı, uzaktan kumanda cihazları, bujiler ve voltaj ölçer cihazların temizliğinde kullanılabilir.

Sip. Kodu: 9771

3,25 \$



HAWCON®



HW 02 - Yağlı Kontak Spreyi
Contact Cleaner

200 ml.

Her türlü mekanik ve elektronik parçaları temizler, yağlar ve korur. Elektrik iletkenliğini artırır. Neme, toza ve paslanmaya karşı etkilidir.

Sip. Kodu: 9772

3,25 \$

PERFECTS SPREY ÇEŞİTLERİ

YETKİLİ BAYI

Yağlı Kontak Spreyi / Contact Cleaner



200 ml.

Her türlü mekanik ve elektronik parçaları temizler, yağlar ve korur. Elektrik iletkenliğini artırır. Neme, toza ve paslanmaya karşı etkilidir.

Sip. Kodu: 9773

3,71 €

Yağsız Kontak Spreyi / Degreaser Cleaner



200 ml.

Kirli ve yıpranabilir yüzeyler, elektronik bağlantıları, fişler, voltaj regülatörleri, akım düzenleyiciler, telefon aksamı, uzaktan kumanda cihazları, bujiler ve voltaj ölçer cihazların temizliğinde kullanılabilir.

Sip. Kodu: 9774

4,35 €

Köpük Temizleyici Sprey / Instant Cleaner



200 ml.

Tüm kalıcı kirleri, akıntıları, parmak izlerini temizleyen yoğun köpük. Seramikler, cam, ahşap ve plastik yüzeylerde, bilgisayarlarda, elektronik ürünlerde güvenle kullanılabilir.

Sip. Kodu: 9775

3,92 €

Etiket Çıkarıcı Sprey / Label Remover



200 ml.

Bir artık bırakmaksızın etiketleri çıkarır. Kullanımı hızlı ve etkilidir. El tipi fırça uygulayıcısı vardır.

Sip. Kodu: 9776

4,88 €

Dondurucu Sprey / Freeze Spray



200 ml.

Cihazların ısıya karşı hassas olan devrelerinde elektrikle ilgili oluşan hataları bulmada çabuk donarak -50°C'ye kadar etkilidir. Lehim sırasında parçaları korur aynı zamanda yapışkan sıvı, artıklar ve mum yağını çıkarmada yardımcı olur.

Sip. Kodu: 9777

15,90 €

Plastik 70 Silikon Sprey



400 ml.

Yüksek düzeyde izolasyon özelliğine sahip, saydam kaplama, akrilik reçine içermektedir. Ve sulandırılmıştır. Korumucu film gibi kaplar. Sıcaklık aralığı -70°C ile 100°C'dir.

Sip. Kodu: 9778

28,00 € / Adet

FLU / Elektronik Kart Temizleyici (Fırçalı)



Kod: 82009

400 ml.

Baskılı devre kartlarının her açından mükemmel şekilde temizlenmesini sağlar. Her türlü kaynak tozunu temizler, geride atık bırakmaz, çabuk kurur. Yüksek derecede izolasyon direnci sağlar.

Sip. Kodu: 9779

20,00 € / Adet

WD - 40 Pas Önleyici Sprey



200 ml.

Aletleri ve mekanikleri korozyondan korur. Yüksek nemli ve tuzlu (marin) çevrelerde kullanım için idealdir.

Sip. Kodu: 9780

300,00 ₺ / Adet

WD - 40 Pas Önleyici Sprey



400 ml.

Aletleri ve mekanikleri korozyondan korur. Yüksek nemli ve tuzlu (marin) çevrelerde kullanım için idealdir.

Sip. Kodu: 9781

450,00 ₺ / Adet









ANAHTAR VE SWITCH GRUBU

-duyar-
motorpompa®

Yenilikçi bina teknolojileri



YERLİ ANAHTAR VE SWITCH ÇEŞİTLERİ

Difaze Işıklı Anahtar  HWA-001 Sip. Kodu: 9801 0,65 \$ / Ad.	Difaze Işıklı Klemensli Anahtar  4 Vidalı (16A) HWA-002 Sip. Kodu: 9802 0,72 \$ / Ad.	Difaze Işıksız Anahtar  HWA-003 Sip. Kodu: 9803 0,60 \$ / Ad.	Difaze Çift Tarafa Yaylı Asansör Şalteri  HWA-004 Sip. Kodu: 9804 0,93 € / Ad.
İkili Işıklı Anahtar  HWA-005 Sip. Kodu: 9805 0,80 \$ / Ad.	İkili Işıksız Anahtar  HWA-006 Sip. Kodu: 9806 0,60 \$ / Ad.	Tekli Işıklı Anahtar  HWA-007 Sip. Kodu: 9807 0,40 \$ / Ad.	Tekli Işıksız Anahtar  HWA-008 Sip. Kodu: 9808 0,35 \$ / Ad.
Üçlü Işıklı Anahtar  HWA-009 Sip. Kodu: 9809 1,40 \$ / Ad.	Üçlü Işıksız Anahtar  HWA-010 Sip. Kodu: 9810 1,10 \$ / Ad.	Anh. Işıklı Topraklı Erkek Fiş  HWA-013 Sip. Kodu: 9811 2,00 \$ / Ad.	İpli Switch  HWA-015 Sip. Kodu: 9812 25,00 ₺ / Ad.
Çıt Çıt Anahtar  HWA-016 Sip. Kodu: 9813 0,21 \$ / Ad.	16 A Düz Dolap Switch  HWA-019A Sip. Kodu: 9814 0,60 \$ / Ad.	16 A Ters Dolap Switch  HWA-019 Sip. Kodu: 9815 0,60 \$ / Ad.	25 A Şofben Switch  HWA-020 Sip. Kodu: 9816 0,75 \$ / Ad.
Uzun Paletli Micro Switch  HWA-170 Sip. Kodu: 9817 0,48 \$ / Ad.	Paletsiz Micro Switch  HWA-170-0 Sip. Kodu: 9818 0,48 \$ / Ad.	Uzun Makaralı Micro Switch  HWA-171 Sip. Kodu: 9819 0,48 \$ / Ad.	Kısa Makaralı Micro Switch  HWA-172 Sip. Kodu: 9820 0,48 \$ / Ad.
Monofaze Pompalı Şalter 20 A  HWA-021 Sip. Kodu: 9821 175,00 ₺ / Ad.	Trifaze Pompalı Şalter 20 A  HWA-022 Sip. Kodu: 9822 175,00 ₺ / Ad.		

İTHAL ANAHTAR VE SWITCH ÇEŞİTLERİ

İkili Işıklı Anahtar 6P ON/OFF  HWA-101 Sip. Kodu: 9823 0,72 \$ / Ad.	İkili Işıksız Anahtar 4P ON/OFF  HWA-103 Sip. Kodu: 9824 0,52 \$ / Ad.	Difaze Işıklı Anahtar 4P ON/OFF  HWA-104 Sip. Kodu: 9825 0,50 \$ / Ad.	Difaze Işıklı Anahtar 6P ON/OFF  HWA-104A Sip. Kodu: 9826 0,70 \$ / Ad.
Körüklü Geniş Işıklı Anahtar 4P ON/OFF  HWA-104W Sip. Kodu: 9827 1,25 \$ / Ad.	Geniş Işıklı Anahtar 6P ON/OFF/ON  HWA-105 Sip. Kodu: 9828 0,68 \$ / Ad.	Körüklü Geniş Işıksız Anahtar 6P ON/OFF/ON  HWA-108W Sip. Kodu: 9829 1,68 \$ / Ad.	Yaylı Geniş Işıksız Anahtar 6P ON/OFF/ON  HWA-110 Sip. Kodu: 9830 0,70 \$ / Ad.
Geniş Anahtar Kılıfı  HWA-112 Sip. Kodu: 9831 0,27 \$ / Ad.	Tekli Dar Işıklı Anahtar 3P ON/OFF  HWA-113 Sip. Kodu: 9832 0,35 \$ / Ad.	Tekli Dar Işıksız Anahtar 2P ON/OFF  HWA-114 Sip. Kodu: 9833 0,27 \$ / Ad.	Tekli Dar Işıksız Anahtar 3P ON/OFF/ON  HWA-115 Sip. Kodu: 9834 0,41 \$ / Ad.
Mini Işıklı Anahtar 3P ON/OFF  HWA-118 Sip. Kodu: 9835 0,35 \$ / Ad.	Mini Işıklı Anahtar 4P ON/OFF  HWA-119 Sip. Kodu: 9836 0,38 \$ / Ad.	Mini Işıksız Anahtar 2P ON/OFF  HWA-120 Sip. Kodu: 9837 0,16 \$ / Ad.	Mini Işıksız Anahtar 3P ON/ON  HWA-121 Sip. Kodu: 9838 0,20 \$ / Ad.
Mini Işıksız Anahtar 4P ON/OFF  HWA-122 Sip. Kodu: 9839 0,33 \$ / Ad.	Mini Işıksız Anahtar 3P ON/OFF/ON  HWA-0123 Sip. Kodu: 9840 0,27 \$ / Ad.	Yaylı Mini Işıksız Anahtar 3P ON/OFF/ON  HWA-123A Sip. Kodu: 9841 0,58 \$ / Ad.	Yaylı Mini Işıksız Anahtar 2P ON/OFF  HWA-124 Sip. Kodu: 9842 0,27 \$ / Ad.
(S) Mini Işıksız Anahtar 2P ON/OFF  HWA-125B Sip. Kodu: 9843 0,15 \$ / Ad.	Orta Boy Işıklı Anahtar 4P ON/OFF  HWA-126 Sip. Kodu: 9844 0,51 \$ / Ad.	Orta Boy Işıksız Anahtar 4P ON/OFF  HWA-127 Sip. Kodu: 9845 0,38 \$ / Ad.	Yuvarlak Işıklı Anahtar 3P ON/OFF  HWA-131 Sip. Kodu: 9846 0,35 \$ / Ad.

İTHAL ANAHTAR VE SWITCH ÇEŞİTLERİ

Yuvarlak Işıklı Anahtar 3P 12 V DC ON/OFF  HWA-131A Sip. Kodu: 9847 0,38 \$ / Ad.	Yuvarlak Işıklı Anahtar 4P ON/OFF  HWA-131-4 Sip. Kodu: 9848 0,54 \$ / Ad.	Körüklü Yuvarlak Işıklı Anh. 3P ON/OFF  HWA-131W Sip. Kodu: 9849 1,22 \$ / Ad.	Yuvarlak Işıksız Anahtar 2P  HWA-133A ON/OFF  Sip. Kodu: 9850 0,28 \$ / Ad.
Yuvarlak Işıksız Anahtar 3P ON/OFF/ON  HWA-134 Sip. Kodu: 9851 0,35 \$ / Ad.	Oval Işıklı Anahtar 3P ON/OFF  HWA-134B Sip. Kodu: 9852 0,35 \$ / Ad.	Oval Işıksız Anahtar 2P ON/OFF  HWA-134C Sip. Kodu: 9853 0,27 \$ / Ad.	(S) Mini Yuvarlak Işıklı Anh. 3P ON/OFF  HWA-134D Sip. Kodu: 9854 0,48 \$ / Ad.
(S) Mini Yuvarlak Işıksız Anh. 2P ON/OFF  HWA-134E Sip. Kodu: 9855 0,25 \$ / Ad.	Üçlü Işıklı Anahtar 9P ON/OFF  HWA-135 Sip. Kodu: 9856 1,23 \$ / Ad.	Üçlü Işıksız Anahtar 9P ON/OFF  HWA-136 Sip. Kodu: 9857 1,10 \$ / Ad.	Orta Boy Toggle Switch 2P 2 A ON/OFF  HWA-149 Sip. Kodu: 9858 0,58 \$ / Ad.
Metal Buton 10 mm  HWA-179 Sip. Kodu: 9859 0,25 \$ / Ad.	Metal Buton 16 mm  HWA-180 Sip. Kodu: 9860 0,36 \$ / Ad.	Plastik Buton 16 mm  HWA-180A Sip. Kodu: 9861 0,36 \$ / Ad.	Düz Metal Buton (PBS28B-2) 19 mm  HWA-182 Sip. Kodu: 9862 2,50 \$ / Ad.
Yüksek Metal Buton 19 mm  HWA-182H Sip. Kodu: 9863 2,50 \$ / Ad.	Plastik Buton (PBS33B) 12 mm  HWA-184 Sip. Kodu: 9864 0,58 \$ / Ad.	Kapak Switch 12 mm  HWA-187A Sip. Kodu: 9865 0,50 \$ / Ad.	Yaylı Buton Plastik 2P  HWA-191C Sip. Kodu: 9866 0,36 \$ / Ad.

TOGGLE SWITCH

Sip. Kodu	Kod	Açıklama	Ad. / \$
9867	HWA-152S	ON/OFF 3P Vidalı 15A	2,80 \$
9868	HWA-152-2S	ON/OFF 2P Vidalı 15A	2,40 \$
9869	HWA-153S	ON/OFF/ON 3P Vidalı 15A	2,80 \$
9870	HWA-155S	(ON)/OFF/(ON) 3P Vidalı Yaylı 15A	3,00 \$

SWION

TOGGLE SWITCH

























Sip. Kodu	Kod	Açıklama	Ad. / \$
9871	HWA-157S	ON/OFF 6P Vidalı 15A	3,75 \$
9872	HWA-158S	ON/OFF/ON 6P Vidalı 15A	3,75 \$
9873	HWA-159	(ON)/OFF/ON 6P Vidalı Yaylı	2,50 \$
9874	HWA-160	(ON)/OFF/(ON) 6P Vidalı Yaylı	2,50 \$

SWION

BORN KLEMENS BANAN FİŞ VE KROKODİL ÇEŞİTLERİ

Banan Jak (Cx-02) HWA-238 Sip. Kodu: 9875 0,14 \$ / Ad.	Banan Jak (Cx-03) HWA-238A Sip. Kodu: 9876 0,19 \$ / Ad.	Banan Jak (Silikonlu) HWA-238B Sip. Kodu: 9877 0,68 \$ / Ad.	Banan Jak (Kare) HWA-238C Sip. Kodu: 9878 0,43 \$ / Ad.
Banan Jak (Üçgen) HWA-238D Sip. Kodu: 9879 0,27 \$ / Ad.	Banan Jak (Korunmalı Tip) 4 mm HWA-238E Sip. Kodu: 9880 0,72 \$ / Ad.	Born Klemens (Büyük Boy) HWA-239 Sip. Kodu: 9881 0,27 \$ / Ad.	Born Klemens (B. Boy Korunmalı) HWA-239A Sip. Kodu: 9882 0,57 \$ / Ad.
Born Klemens (B. Boy Korunmalı) Vida Bacaklı HWA-239B Sip. Kodu: 9883 0,57 \$ / Ad.	Born Klemens (Orta Boy) HWA-240 Sip. Kodu: 9884 0,23 \$ / Ad.	Born Klemens (Büyük Boy) Şeffaf HWA-240B Sip. Kodu: 9885 0,36 \$ / Ad.	Born Klemens (Orta Boy) Şeffaf HWA-240C Sip. Kodu: 9886 0,12 \$ / Ad.
Born Klemens 100A HWA-260 Sip. Kodu: 9887 671,00 ₺ / Ad.	Born Klemens 63A HWA-261 Sip. Kodu: 9888 424,00 ₺ / Ad.	Born Klemens 32A HWA-262 Sip. Kodu: 9889 354,00 ₺ / Ad.	Hirschmann Krokodil AK-25 HWA-263 Sip. Kodu: 9890 9,30 € / Ad.
Timsah Ağızlı Krokodil 66 mm HWA-243 Sip. Kodu: 9891 0,12 \$ / Ad.	Banan Jak Girişli Krokodil HWA-243A Sip. Kodu: 9892 1,00 \$ / Ad.	Banan Jak Girişli Krokodil (4mm) HWA-243C Sip. Kodu: 9893 2,80 \$ / Ad.	Kablolu Krokodil (Küçük Boy) HWA-247 Sip. Kodu: 9894 0,18 \$ / Ad.
Kablolu Krokodil (Büyük Boy) HWA-247A Sip. Kodu: 9895 0,28 \$ / Ad.	İzoleli Krokodil (Orta Boy) 35 mm HWA-248A Sip. Kodu: 9896 0,08 \$ / Ad.	İzoleli Krokodil (Büyük Boy) 42,5 mm HWA-248B Sip. Kodu: 9897 0,10 \$ / Ad.	İzoleli Krokodil (2 mm) HWA-243D Sip. Kodu: 9898 1,00 \$ / Ad.

AKÜ MAŞALARI VE ŞASE PENSE ÇEŞİTLERİ

<p>Akü Takviye Pensesi</p>  <p>HWA-380 Bakır Kaplama Sip. Kodu: 9899 250,00 ₺ / Ad.</p>	<p>Akü Takviye Pensesi</p>  <p>HWA-381 Kadyum Kaplama Sip. Kodu: 9900 30,00 ₺ / Ad.</p>	<p>Akü Takviye Pensesi</p>  <p>HWA-382 PVC Cam Elyaf Sip. Kodu: 9901 3,50 \$ / Tk.</p>	<p>Akü Takviye Pensesi</p>  <p>HWA-383 Sip. Kodu: 9902 110,00 ₺ / Ad.</p>
<p>Akü Takviye Pensesi</p>  <p>HWA-384 Sip. Kodu: 9903 160,00 ₺ / Tk.</p>	<p>Mini Akü Takviye Pensesi</p>  <p>HWA-385 Bakır Kaplama Sip. Kodu: 9904 25,00 ₺ / Ad.</p>	<p>Akü Pensesi (Orta Boy)</p>  <p>HWA-386 Kalay Kaplama Sip. Kodu: 9905 0,25 \$ / Ad.</p>	<p>Bakır Kaplı Akü Pensesi</p>  <p>HWA-387 Sip. Kodu: 9906 4,00 \$ / Tk.</p>
<p>Bakır Kaplı Maşa 13 cm</p>  <p>HWA-388 Sip. Kodu: 9907 1,00 \$ / Ad.</p>	<p>Komple İzoleli Orta Boy</p>  <p>HWA-244A Sip. Kodu: 9908 0,40 \$ / Ad.</p>	<p>200A Topraklama Şase Pensesi</p>  <p>HWA-390 Sip. Kodu: 9909 20,00 \$ / Ad.</p>	<p>400A Topraklama Şase Pensesi</p>  <p>HWA-391 Sip. Kodu: 9910 32,00 \$ / Ad.</p>
<p>600A Topraklama Şase Pensesi</p>  <p>HWA-392 Sip. Kodu: 9911 48,00 \$ / Ad.</p>	<p>300A Şase Pensesi</p>  <p>HWA-389 Sip. Kodu: 9912 6,00 \$ / Ad.</p>	<p>500A Şase Pensesi</p>  <p>HWA-389A Sip. Kodu: 9913 8,50 \$ / Ad.</p>	<p>Normal Tip Akü Kutup Başı</p>  <p>HWA-393 Sip. Kodu: 9914 200,00 ₺ / Ad.</p>
<p>Marin Tip Akü Kutup Başı</p>  <p>HWA-394 Sip. Kodu: 9915 175,00 ₺ / Ad.</p>	<p>Kelebek Tip Akü Kutup Başı</p>  <p>HWA-397 Sip. Kodu: 9916 175,00 ₺ / Ad.</p>	<p>Man Tipi Akü Kutup Başı</p>  <p>HWA-396 Sip. Kodu: 9917 165,00 ₺ / Ad.</p>	<p>Kurşun Tip Akü Kutup Başı</p>  <p>HWA-395 Sip. Kodu: 9918 3,50 \$ / Ad.</p>
<p>Kutup Başı Kapşon (Siyah)</p>  <p>HWA-398 Sip. Kodu: 9819 42,00 ₺ / Ad.</p>	<p>Kutup Başı Kapşon (Kırmızı)</p>  <p>HWA-399 Sip. Kodu: 9820 42,00 ₺ / Ad.</p>	<p>Metal Sinyal Lambası (8 mm)</p>  <p>HWA-225 12V - 24V - 220V Sip. Kodu: 9821 0,60 \$ / Ad.</p>	<p>Sinyal Lambası (10 mm)</p>  <p>HWA-227 220V Sip. Kodu: 9822 0,29 \$ / Ad.</p>

FUSE YUVA ve CAM SİGORTALAR

İthal Fuse Sigorta Yuvası

KOD: HWS-236
5 x 20mm



KOD: HWS-236B
6 x 30mm

Sip. Kodu: 9923 1,15 \$ / Adet Sip. Kodu: 9924 1,35 \$ / Adet

Yerli Fuse (5x20mm)

KOD: HWS-237



Sip. Kodu: 9925 35,00 ₺ / Adet

Kablolu Sigorta Yuvası (5x20)(6x30) ÇİN

KOD: HWS-237C
5 x 20mm



KOD: HWS-237C-2
6 x 30mm

Sip. Kodu: 9926 0,25 \$ / Adet Sip. Kodu: 9927 0,30 \$ / Adet

Fuse Sigorta Yuvası (5x20mm)

KOD: HWS-235A
12mm / 13mm



Sip. Kodu: 9928 0,35 \$ / Ad.

Fuse Sigorta Yuvası (6x30mm)

KOD: HWS-236
14mm



Sip. Kodu: 9929 0,40 \$ / Ad.

Oto Tip Kablolu Sigorta Yuvası (Bıçak Tip)

KOD: HWS-237D



Sip. Kodu: 9930 0,90 \$ / Adet

ÇİN Oto Tipi Bıçak Sigorta (Küçük Boy)



1 A
2 A
3 A
4 A
5 A
7,5 A
10 A
15 A
20 A
25 A
30 A
40 A



Sip. Kodu: 9931 1,50 ₺ NET / Adet

ÇİN Oto Tipi Bıçak Sigorta (Standart)



1 A
2 A
3 A
4 A
5 A
7,5 A
10 A
15 A
20 A
25 A
30 A
40 A



Sip. Kodu: 9932 2,00 ₺ NET / Adet

Oto Tipi Bıçak Sigorta (Büyük Boy)



20 A
30 A
40 A
50 A
60 A
80 A
100 A



Sip. Kodu: 9933 14,00 ₺ NET / Adet



HAWCON Cam Sigorta (5x20)

0.050 MA	250V	0.5 A	250V	7 A	250V
0.100 MA	250V	1 A	250V	8 A	250V
0.150 MA	250V	1.2 A	250V	9 A	250V
0.200 MA	250V	1.6 A	250V	10 A	250V
0.250 MA	250V	2 A	250V	15 A	250V
0.315 MA	250V	2.5 A	250V	20 A	250V
0.400 MA	250V	3.15 A	250V	25 A	250V
0.500 MA	250V	4 A	250V	30 A	250V
0.630 MA	250V	5 A	250V		
0.750 MA	250V	6 A	250V		
0.800 MA	250V	6.3 A	250V		

Sip. Kodu: 9934 0,65 ₺ NET / Adet

HAWCON Cam Sigorta (6x30)

0.5 A	250V	7 A	250V
1 A	250V	8 A	250V
1.2 A	250V	9 A	250V
1.6 A	250V	10 A	250V
2 A	250V	15 A	250V
2.5 A	250V	20 A	250V
3.15 A	250V	25 A	250V
4 A	250V	30 A	250V
5 A	250V		
6 A	250V		
6.3 A	250V		

Sip. Kodu: 9935 0,80 ₺ NET / Adet

-duyar-
motorpompa®

Yenilikçi bina teknolojileri

DUYAR MOTOR POMPA DAH.TİC. İTH. İHR. İML. LTD. ŞTİ.
1490 Sk. No: 2/E-F Ege Ticaret Mrk. Yenişehir / İZMİR
T. + 90 232 449 16 46 - F.+ 90 232 433 25 82
Depo: Adalet Mah. 2132 Sk. No: 3 Salhane - Bayraklı / İZMİR

satis@duyarmotor.com - www.duyarpump.com